





# Ipoli 07



Ipoli is a decorative multifunctional collection centered on the movement of playful swiveling heads atop a slender base. The collection draws inspiration from the design tradition of utilitarian, streamlined task lamps and office lighting, while enfolding Lambert & Fils' unique twist, both poetic and sturdy. Whether employed as a task light, ambient accent, or focal point, each piece will delight any space.

<b>TYPE</b>	Floor
<b>CONSTRUCTION</b>	Tumbled or powder coated aluminum body, head and cover plate Frosted opal acrylic lens Vinyl cord
<b>SPECIFICATIONS</b>	Power consumption: 8W  Colour temperature: fixed 2200K fixed 2700K  Lumen output: TBD  Colour rendering index: $\geq 90$ CRI Colour consistency: 3 SDCM Expected lifetime: $\geq 50\ 000$ h
<b>CONTROL</b>	100-240V touch dimmer only
<b>CORD LENGTH</b>	70" / 178 cm
<b>WEIGHT</b>	3.7lb / 1.7kg
<b>CERTIFICATIONS</b>	     IP20
<b>WARRANTY</b>	2 years

## NOTES

- Dimensions are approximate and may vary slightly

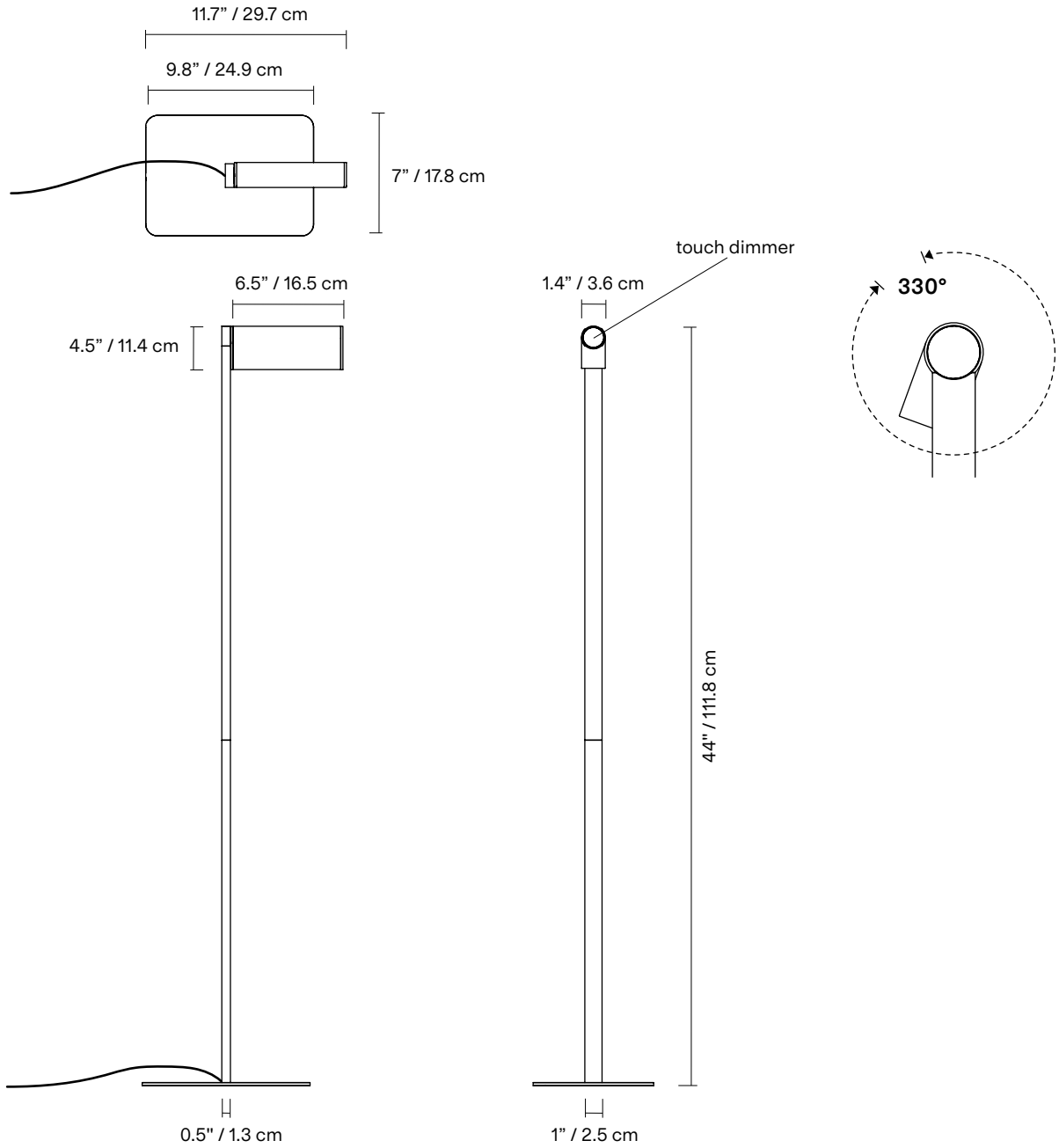

## FINISH



**BG**  
Textured  
beige



**BK**  
Textured  
black



**PP**  
Textured  
poppy



**TA**  
Tumbled  
aluminum

## NOTES

- LED may only be changed by Lambert & Fils or other authorized personnel
- Not protected against liquids (refer to IP20)
- Additional charges for modifications or for special orders
- Please refer to maintenance sheet on our website for cleaning instructions

## LAMP ANATOMY

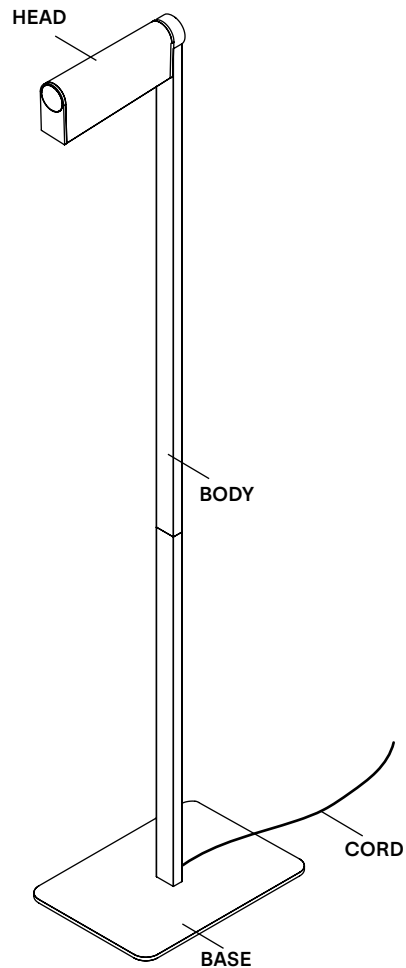

		Example	Fill with your selection
<b>COLLECTION</b>	<b>IPO</b> Ipoli	IPO	<b>IPO</b>
<b>MODEL</b>	<b>07</b>	07	<b>07</b>
<b>CONFIGURATION</b>	<b>TO</b> Touch dimmer	TO	<b>TO</b>
<b>FINISH</b>	<b>BG</b> Textured beige <b>BK</b> Textured black <b>PP</b> Textured poppy <b>TA</b> Tumbled aluminum <b>CC</b> Custom colour*	BG	
<b>CORD</b>	<b>BK</b> black	BK	<b>BK</b>
<b>COLOUR TEMPERATURE (CCT)</b>	<b>F22</b> Fixed 2200K <b>F27</b> Fixed 2700K	F22	
<b>FULL SKU</b>		IPO07TOBGBKF22	
<b>NOTES</b>			

\*Custom colour available upon request. Material library on website.