

WILLIAM GRAY

WILLIAMGRAY.COM @MRWILLIAMGRAY BY MEYER DAVIS



PRODUCT: Hugo Dining Chair

COLLECTION: HUGO

MANUFACTURER: STELLAR WORKS

CURATED BY:
2020, N.Y.C.

William Gray

WG

©2023 WILLIAM GRAY INC.

Hugo Dining Chair

PRODUCT ID

WG-S210

DESCRIPTION

This modern take on a Campaign Chair has been meticulously detailed for dining. The result is a workhorse piece of furniture with a light and nimble footprint. Hugo highlights both sides of a leather hide, adding a fresh layer of texture. A playful strap marries back to the seat. Available in a range of finishes, COM/COL, and customizable upon request, Hugo can sit anywhere.

DIMENSIONS

D × W × H × SH
21.1 × 21.5 × 29.7 × 18.13× 18.3 in
536 × 546 × 754 × 465 mm

MATERIAL OPTIONS

Available in all Stellar Works finishes, graded in fabrics & leathers.

WOOD

- a. Natural Oak
- b. Gray Oak
- c. Dark Brown Oak
- d. Onyx Oak
- e. Natural Walnut
- f. Soap Walnut



a



b



c



d



e

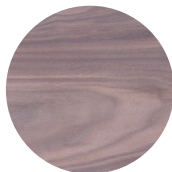

f

Hugo Dining Chair



Hugo Dining Chair



Shown in Crystal Buckskin Leather and Onyx Oak

Hugo Dining Chair



Shown in Newcastle Burgundy Leather and Onyx Oak

Hugo Dining Chair

Plan

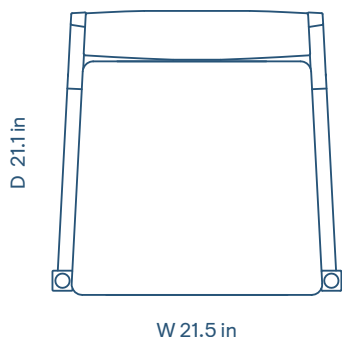

Front Elevation

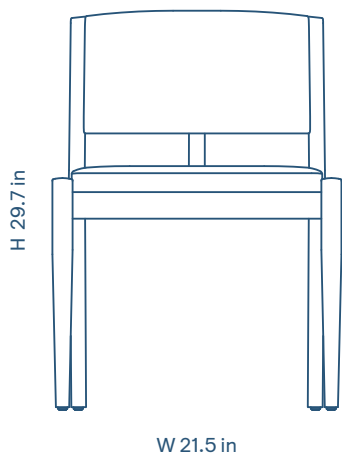

Side Elevation

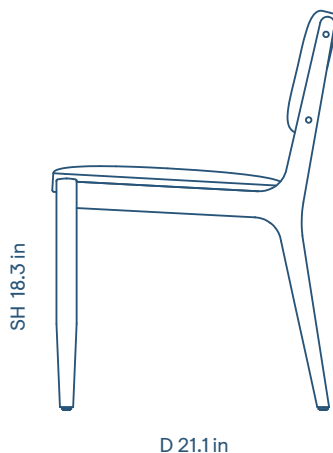

Materials Collection: Fabrics

FABRIC SAMPLES A

Divina Melange
(100% New Wool)

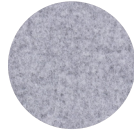

120

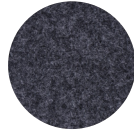

170



180



280

Harald
(100% Cotton)



182



242



283



382

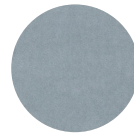

823

Steelcut Trio
(90% New Wool, 10% Nylon)

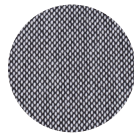

124

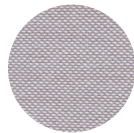

213



383

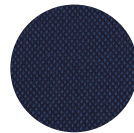

796

FABRIC SAMPLES B

Field
(100% Trevira CS)

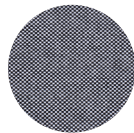

142



182



693



793

Main line flax
(70% virgin wool, 30% flax)



16



20



28

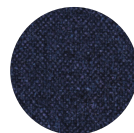

36

Melange Nap

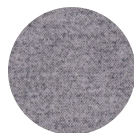

111

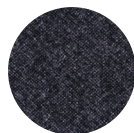

191

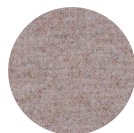

211

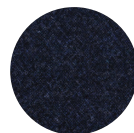

791

Messenger
(70% virgin wool, 30% flax)



Ash 077



Bayou 008

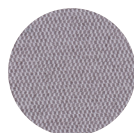

Fossil 076

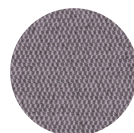

Husk 081

Materials Collection: Fabrics

FABRIC SAMPLES C

Cotton
(100% Cotton)



414

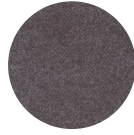

4114

Era
(100% Polyester)

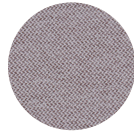

Cse 02



Cse 13



Cse 14



Cse 45

Linen
(100% Linen)



421



422

Manhattan
(100% PES)



600



801



804

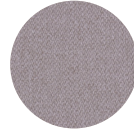

805

Revive 1
(100% recycled FR)



164



184



194

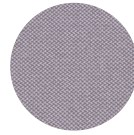

324

Revive 2
(100% recycled polyester FR)

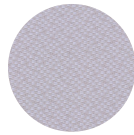

133



183



193



383

Ruby
(100% PES)



104



617



800

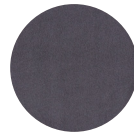

805

Materials Collection: Leathers

LEATHER SAMPLES A

New Castle
(Aniline Leather)



Black New
65



Charcoal New
1365



Dark Brown New
25



Green New
35

LEATHER SAMPLES B

Crystal
(Aniline Leather)



Baltic
3814



Black
9893



Chestnut
8042



Wolf
3386

Milano
(Pigmented Leather)



Black
2522



Milano Brown
0972



Milano Ivory
5020

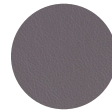

Milano Quartz
2123

LEATHER SAMPLES C

Bellagio
(Pigmented Leather)



Black
7925



Charcoal
4502



Cream
8805



Dark Brown
4501



Quartz
5070

PU LEATHER

Omega
(Surface 100%
Polyurethane,
Base 100% Polyester)



Black



Dark Brown



Grey



Ice

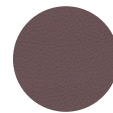

Tabac



Toffee

SADDLE LEATHER



Black



Nude



Brown

WILLIAM GRAY

WILLIAMGRAY.COM @MRWILLIAMGRAY BY MEYER DAVIS



PRODUCT: Hugo Slim Dining Chair

COLLECTION: Hugo

MANUFACTURER: STELLAR WORKS

CURATED BY:
2020, N.Y.C.

William Gray

WG

© 2023 WILLIAM GRAY INC.

Hugo Slim Dining Chair

PRODUCT ID

WG-S220

DESCRIPTION

This modern take on a Campaign Chair has been meticulously detailed for dining. The result is a workhorse piece of furniture with a light and nimble footprint. Hugo highlights both sides of a leather hide, adding a fresh layer of texture. A playful strap marries back to the seat. Hugo Slim is designed with a sleeker profile, more appropriate for residential use. Available in a range of finishes, COM/COL, and customizable upon request, Hugo can sit anywhere.

DIMENSIONS

D × W × H × SH
21.1 × 18 × 29.7 × 18.3 in
536 × 456 × 754 × 465 mm

MATERIAL OPTIONS

Available in all Stellar Works finishes, graded in fabrics & leathers.

WOOD

- a. Natural Oak
- b. Gray Oak
- c. Dark Brown Oak
- d. Onyx Oak
- e. Natural Walnut
- f. Soap Walnut



a



b



c



d



e



f

Hugo Slim Dining Chair



Hugo Slim Dining Chair



Hugo Slim Dining Chair

Plan

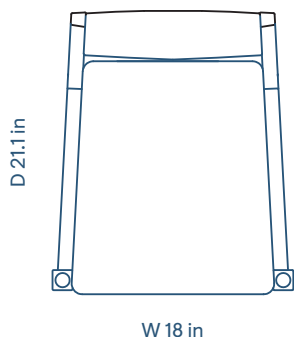

Front Elevation

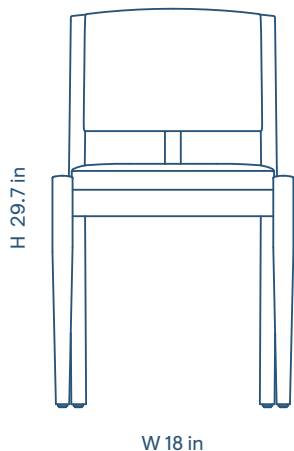

Side Elevation

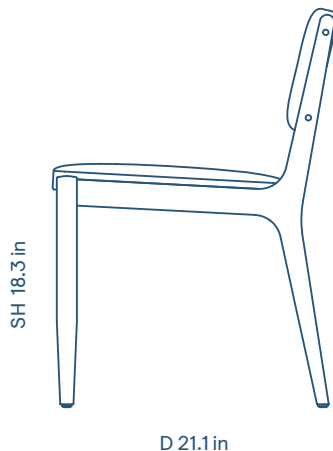

Materials Collection: Leathers

LEATHER SAMPLES A

New Castle
(Aniline Leather)



Black New
65



Charcoal New
1365



Dark Brown New
25



Green New
35

LEATHER SAMPLES B

Crystal
(Aniline Leather)



Baltic
3814



Black
9893



Chestnut
8042



Wolf
3386

Milano
(Pigmented Leather)



Black
2522



Milano Brown
0972



Milano Ivory
5020

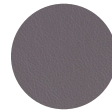

Milano Quartz
2123

LEATHER SAMPLES C

Bellagio
(Pigmented Leather)



Black
7925



Charcoal
4502



Cream
8805



Dark Brown
4501



Quartz
5070

PU LEATHER

Omega
(Surface 100%
Polyurethane,
Base 100% Polyester)



Black



Dark Brown



Grey



Ice

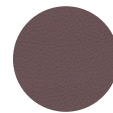

Tabac



Toffee

SADDLE LEATHER



Black



Nude



Brown

Materials Collection: Fabrics

FABRIC SAMPLES C

Cotton
(100% Cotton)



414



4114

Era
(100% Polyester)



Cse 02



Cse 13



Cse 14



Cse 45

Linen
(100% Linen)



421



422

Manhattan
(100% PES)



600



801



804



805

Revive 1
(100% recycled FR)



164



184



194

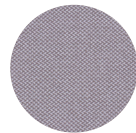

324

Revive 2
(100% recycled polyester FR)

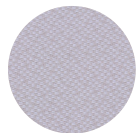

133



183



193



383

Ruby
(100% PES)



104



617



800



805

Materials Collection: Fabrics

FABRIC SAMPLES A

Divina Melange
(100% New Wool)

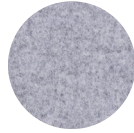

120

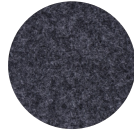

170



180



280

Harald
(100% Cotton)



182



242



283



382

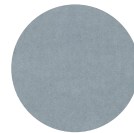

823

Steelcut Trio
(90% New Wool, 10% Nylon)

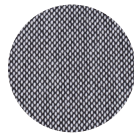

124

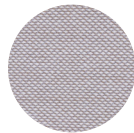

213



383

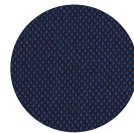

796

FABRIC SAMPLES B

Field
(100% Trevira CS)

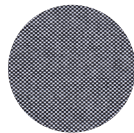

142



182



693



793

Main line flax
(70% virgin wool, 30% flax)



16



20



28

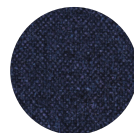

36

Melange Nap

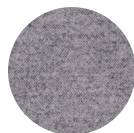

111

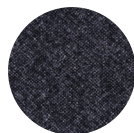

191

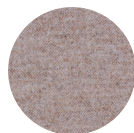

211

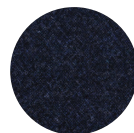

791

Messenger
(70% virgin wool, 30% flax)



Ash 077



Bayou 008



Fossil 076

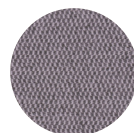

Husk 081