

Silo 2F

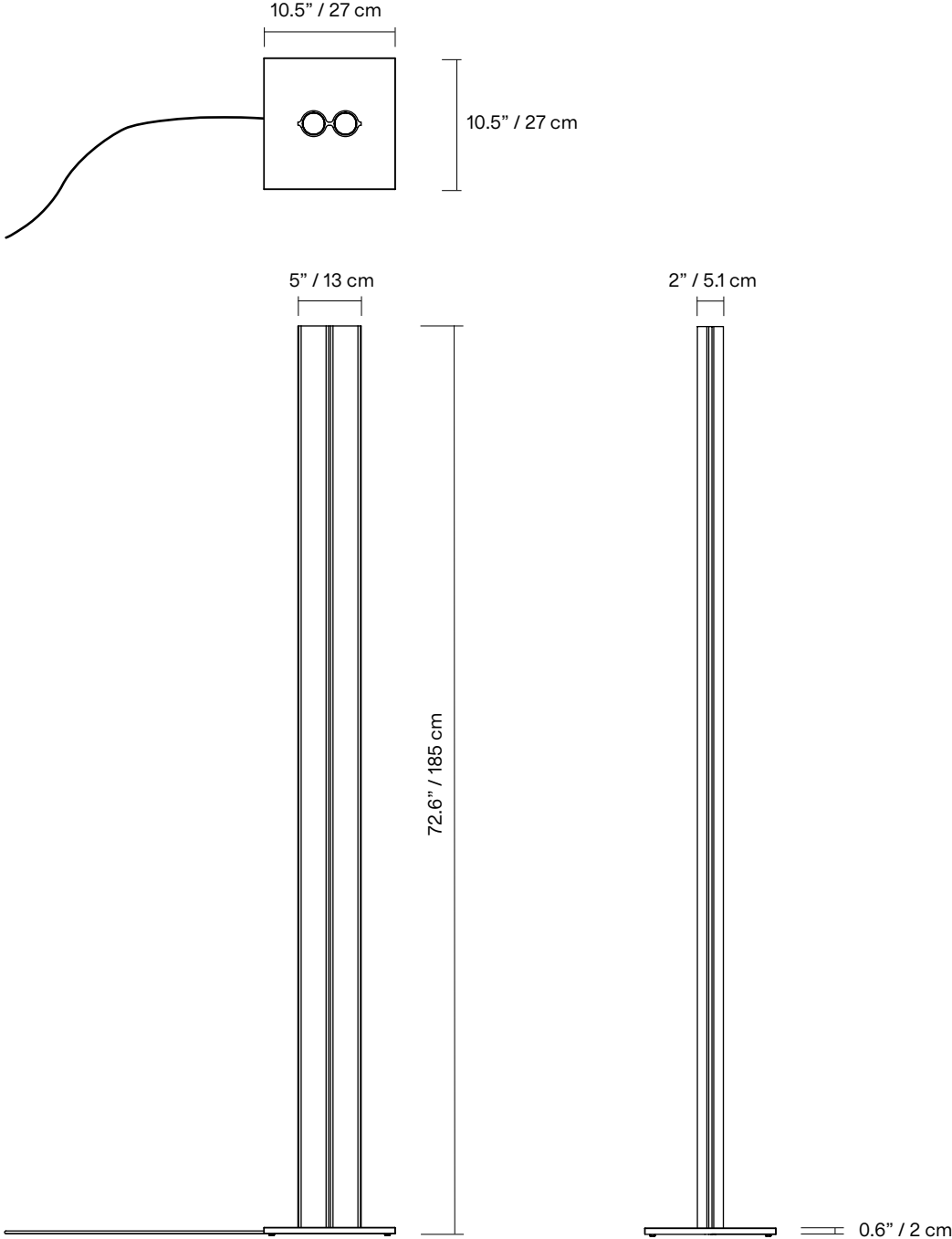

The Silo collection inhabits many worlds at once, creating a striking metaphor for duality. Mysterious yet inviting, the true magic lies in how its rhythmic curves shape light and space around it. Made using custom aluminium extrusions, the modular uplight-downlight creates a theatrical yet sleek composition.

TYPE	Floor
CONSTRUCTION	Powder coated or mirror polished aluminum body Polished aluminum base Satin polished aluminum base Polycarbonate lens Vinyl cord
SPECIFICATIONS	Source: LED array integrated Power consumption: 7.6W Colour temperature : 3000K 2700K dim to warm 3000K to 2200K dim to warm 2700K to 2200K Lumen output: 3000K - 455lm 2700K - 433lm Colour rendering index: ≥90 CRI Colour consistency: 3 SDCM Expected lifetime: ≥50 000h
CONTROL	100-240 VAC Plug-in Driver, foot control dimmer
CORD	foot switch: 96"/ 244 cm provided switch positioned at 24"/ 61 cm from body
WEIGHT	23.5 lb / 10.7 Kg
WARRANTY	2 years



*dimensions are approximate and may vary slightly

FINISH



BK
Textured
black



WH
Textured
white



MR
Mirror
polished



BG
Textured
beige



DP
Wrinkled
dusty pink



TC
Textured
terracotta



AU
Textured
aubergine



OB
Glossy
oxblood



MB
Textured
midnight blue

CORD



BK
Black

CONFIGURATION

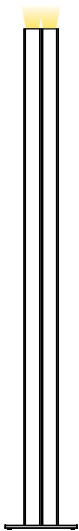

NOTES

- Not protected against liquids (refer to IP20)
- Additional charges for modifications or for special orders
- Please refer to maintenance sheet on our website for cleaning instructions

LAMP ANATOMY

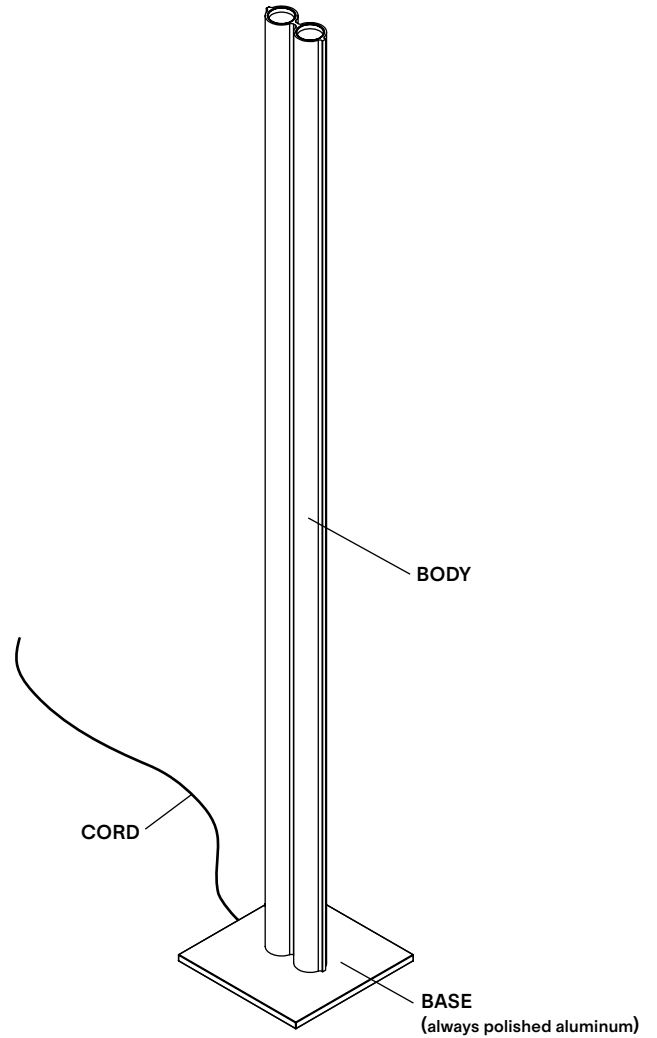

		Example	Fill with your selection
COLLECTION	SIL Silo	SIL	SIL
MODEL	2F	2F	2F
SHAPE	G	G	G
BODY	BK Textured black WH Textured white MR Mirror polished aluminum BG Textured beige DP Wrinkled dusty pink TC Textured terracotta AU Textured aubergine OB Glossy oxblood MB Textured midnight blue CC Custom colour*	BK	
CORD	BK Black	BK	BK
COLOUR TEMPERATURE (CCT)	WL Warm light (2700K) NL Neutral light (3000K) D27 Dim to warm (2700K-2200K) D30 Dim to warm (3000K-2200K) CCT Other CCT available upon request**	WL	
FULL SKU		SIL2FGBKBKWL	
		NOTES	

*Custom colour available upon request. Material library on website.

**Other CCT: 2200K, 3500K and 4000K (not available in Dim-to-Warm feature)

Silo 2T



The Silo collection inhabits many worlds at once, creating a striking metaphor for duality. Mysterious yet inviting, the true magic lies in how its rhythmic curves shape light and space around it. Made using custom aluminium extrusions, the modular uplight-downlight creates a theatrical yet sleek composition

TYPE	Table
CONSTRUCTION	Powder coated, mirror polished or tumbled aluminum body Polycarbonate lens Vinyl cord
SPECIFICATIONS	Source: LED array integrated Power consumption: 7.6W Colour temperature : 3000K 2700K dim to warm 3000K to 2200K dim to warm 2700K to 2200K Lumen output: 3000K - 455lm 2700K - 433lm Colour rendering index: ≥90 CRI Colour consistency: 3 SDCM Expected lifetime: ≥50 000h
CONTROL	100-240 VAC Plug-in Driver, cord dimmer
CORD LENGTH	96" / 244 cm provided cord dimmer positioned at 18" / 46 cm from body
WARRANTY	2 years

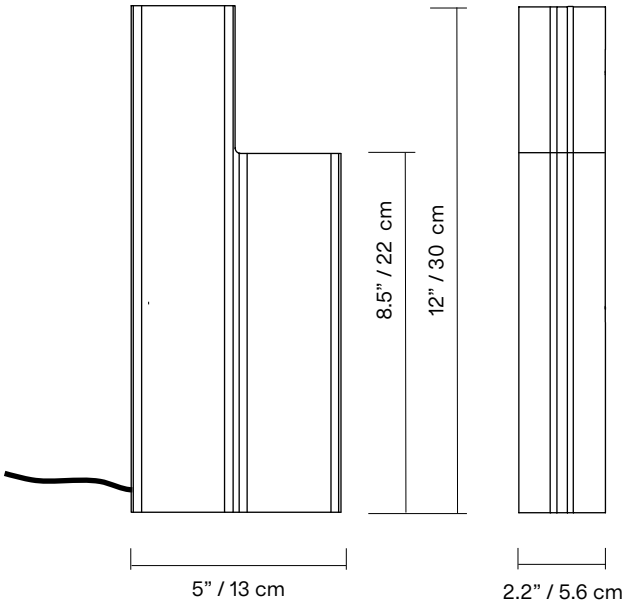
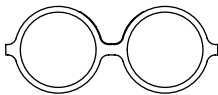

*dimensions are approximate and may vary slightly

FINISH



BK
Textured
black



WH
Textured
white



MR
Mirror
polished



TA
Tumbled
aluminum



BG
Textured
beige



DP
Wrinkled
dusty pink



TC
Textured
terracotta



AU
Textured
aubergine



OB
Glossy
oxblood



MB
Textured
midnight blue

CORD



BK
Black

NOTES

- Not protected against liquids (refer to IP20)
- Additional charges for modifications or for special orders
- Please refer to maintenance sheet on our website for cleaning instructions

LAMP ANATOMY

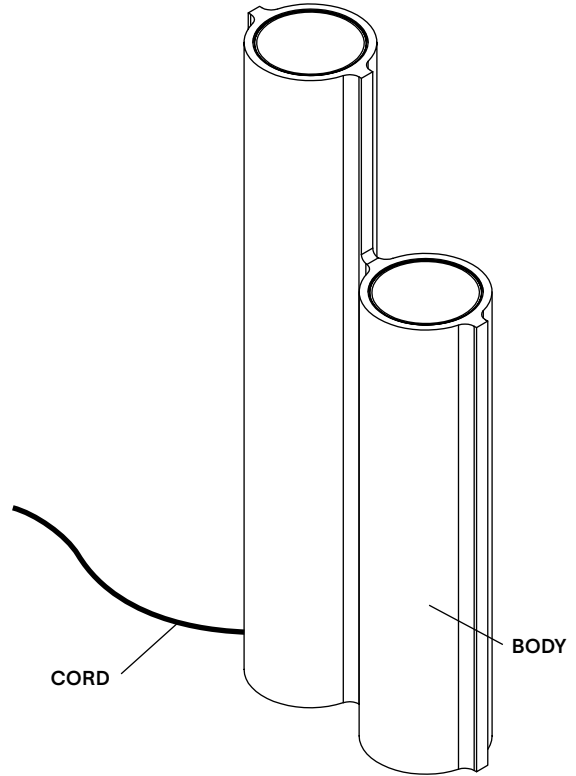

		Example	Fill with your selection
COLLECTION	SIL Silo	SIL	SIL
MODEL	2T	2T	2T
SHAPE	F	F	F
BODY	BK Textured black WH Textured white MR Mirror polished aluminum TA Tumbled aluminum BG Textured beige DP Wrinkled dusty pink TC Textured terracotta AU Textured aubergine OB Glossy oxblood MB Textured midnight blue CC Custom colour*	BK	
CORD	BK Black	BK	BK
COLOUR TEMPERATURE (CCT)	WL Warm light (2700K) NL Neutral light (3000K) D27 Dim to warm (2700K-2200K) D30 Dim to warm (3000K-2200K) CCT Other CCT available upon request**	WL	
FULL SKU		SIL2TFBKWKWL	
		NOTES	

*Custom colour available upon request. Material library on website.

**Other CCT: 2200K, 3500K and 4000K (not available in Dim-to-Warm feature)

Silo 3F



The Silo collection inhabits many worlds at once, creating a striking metaphor for duality. Mysterious yet inviting, the true magic lies in how its rhythmic curves shape light and space around it. Made using custom aluminium extrusions, the modular uplight-downlight creates a theatrical yet sleek composition.

TYPE	Floor
CONSTRUCTION	Powder coated or mirror polished aluminum body Polished aluminum base Satin polished aluminum base Polycarbonate lens Vinyl cord
SPECIFICATIONS	Source: LED array integrated Power consumption: 11.6W Colour temperature : 3000K 2700K dim to warm 3000K to 2200K dim to warm 2700K to 2200K Lumen output: 3000K - 617lm 2700K - 588lm Colour rendering index: ≥90 CRI Colour consistency: 3 SDCM Expected lifetime: ≥50 000h
CONTROL	100-240 VAC Plug-in Driver, foot control dimmer
CORD	foot switch: 96"/ 244 cm provided switch positioned at 24"/ 61 cm from body
WEIGHT	28 lb / 12.7 Kg
WARRANTY	2 years

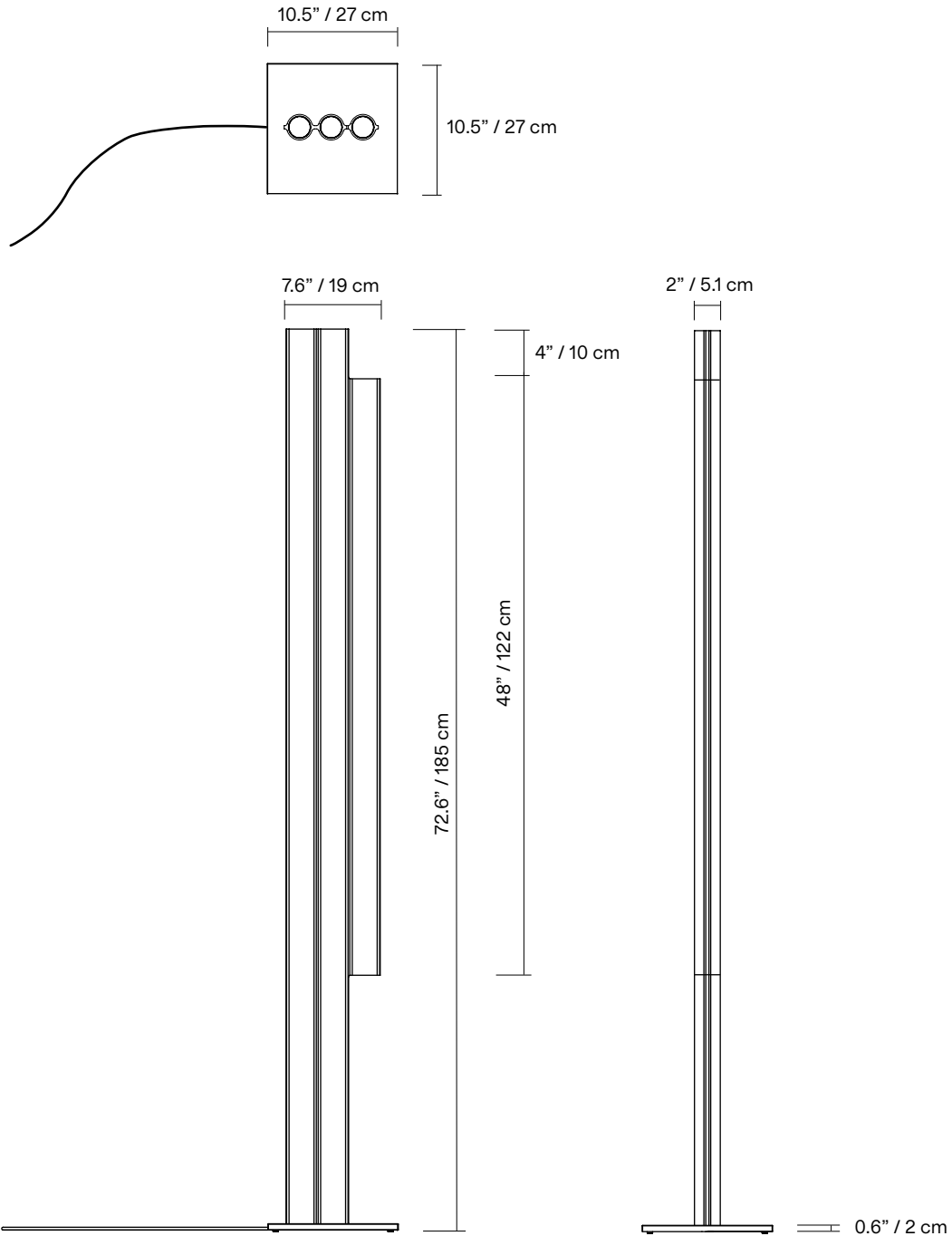

*dimensions are approximate and may vary slightly

FINISH



BK
Textured
black



WH
Textured
white



MR
Mirror
polished



BG
Textured
beige



DP
Wrinkled
dusty pink



TC
Textured
terracotta



AU
Textured
aubergine



OB
Glossy
oxblood



MB
Textured
midnight blue

CORD



BK
Black

CONFIGURATION

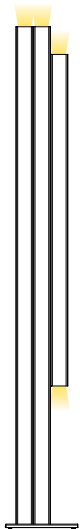

NOTES

- Not protected against liquids (refer to IP20)
- Additional charges for modifications or for special orders
- Please refer to maintenance sheet on our website for cleaning instructions

LAMP ANATOMY

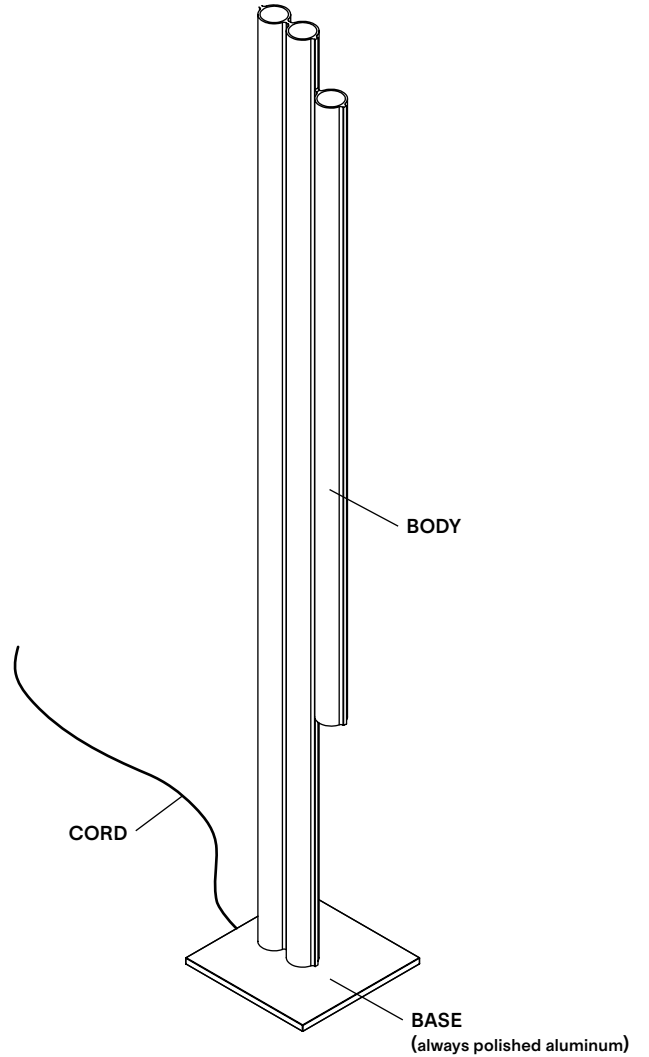

		Example	Fill with your selection
COLLECTION	SIL Silo	SIL	SIL
MODEL	3F	3F	3F
SHAPE	H	H	H
BODY	BK Textured black WH Textured white MR Mirror polished aluminum BG Textured beige DP Wrinkled dusty pink TC Textured terracotta AU Textured aubergine OB Glossy oxblood MB Textured midnight blue CC Custom colour*	BK	
CORD	BK Black	BK	BK
COLOUR TEMPERATURE (CCT)	WL Warm light (2700K) NL Neutral light (3000K) D27 Dim to warm (2700K-2200K) D30 Dim to warm (3000K-2200K) CCT Other CCT available upon request**	WL	
FULL SKU		SIL3FHBKKBKWL	
		NOTES	

*Custom colour available upon request. Material library on website.

**Other CCT: 2200K, 3500K and 4000K (not available in Dim-to-Warm feature)

Silo 3T



The Silo collection inhabits many worlds at once, creating a striking metaphor for duality. Mysterious yet inviting, the true magic lies in how its rhythmic curves shape light and space around it. Made using custom aluminium extrusions, the modular uplight-downlight creates a theatrical yet sleek composition

TYPE	Table
CONSTRUCTION	Powder coated, mirror polished or tumbled aluminum body Polycarbonate lens Vinyl cord
SPECIFICATIONS	Source: LED array integrated Power consumption: 7.6W Colour temperature : 3000K 2700K dim to warm 3000K to 2200K dim to warm 2700K to 2200K Lumen output: 3000K - 455lm 2700K - 433lm Colour rendering index: ≥90 CRI Colour consistency: 3 SDCM Expected lifetime: ≥50 000h
CONTROL	100-240 VAC Plug-in Driver, cord dimmer
CORD LENGTH	96" / 244 cm provided cord dimmer positioned at 18" / 46 cm from body
WARRANTY	2 years

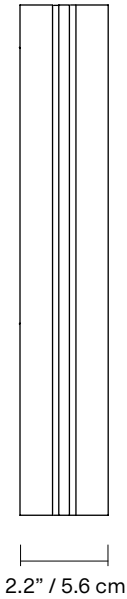
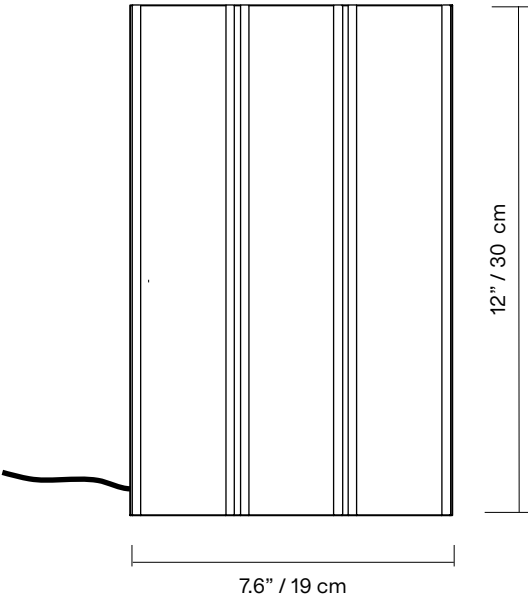

*dimensions are approximate and may vary slightly

FINISH



BK
Textured
black



WH
Textured
white



MR
Mirror
polished



TA
Tumbled
aluminum



BG
Textured
beige



DP
Wrinkled
dusty pink



TC
Textured
terracotta



AU
Textured
aubergine



OB
Glossy
oxblood



MB
Textured
midnight blue

CORD



BK
Black

NOTES

- Not protected against liquids (refer to IP20)
- Additional charges for modifications or for special orders
- Please refer to maintenance sheet on our website for cleaning instructions

LAMP ANATOMY

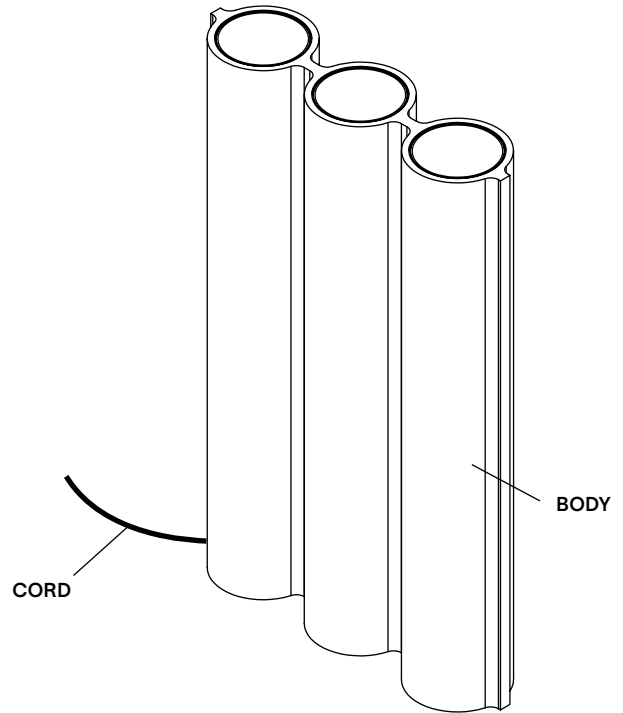

		Example	Fill with your selection
COLLECTION	SIL Silo	SIL	SIL
MODEL	3T	3T	3T
SHAPE	A	A	A
BODY	BK Textured black WH Textured white MR Mirror polished aluminum TA Tumbled aluminum BG Textured beige DP Wrinkled dusty pink TC Textured terracotta AU Textured aubergine OB Glossy oxblood MB Textured midnight blue CC Custom colour*	BK	
CORD	BK Black	BK	BK
COLOUR TEMPERATURE (CCT)	WL Warm light (2700K) NL Neutral light (3000K) D27 Dim to warm (2700K-2200K) D30 Dim to warm (3000K-2200K) CCT Other CCT available upon request**	WL	
FULL SKU		SIL3TABKBKWL	

NOTES

*Custom colour available upon request. Material library on website.

**Other CCT: 2200K, 3500K and 4000K (not available in Dim-to-Warm feature)

Silo 4F



The Silo collection inhabits many worlds at once, creating a striking metaphor for duality. Mysterious yet inviting, the true magic lies in how its rhythmic curves shape light and space around it. Made using custom aluminium extrusions, the modular uplight-downlight creates a theatrical yet sleek composition.

TYPE	Floor
CONSTRUCTION	Powder coated or mirror polished aluminum body Polished aluminum base Satin polished aluminum base Polycarbonate lens Vinyl cord
SPECIFICATIONS	Source: LED array integrated Power consumption: 7.6W Colour temperature : 3000K 2700K dim to warm 3000K to 2200K dim to warm 2700K to 2200K Lumen output: 3000K - 243lm 2700K - 231lm Colour rendering index: ≥90 CRI Colour consistency: 3 SDCM Expected lifetime: ≥50 000h
CONTROL	100-240 VAC Plug-in Driver, foot control dimmer
CORD	foot switch: 96"/ 244 cm provided switch positioned at 24"/ 61 cm from body
WEIGHT	22.5 lb / 10.2 Kg
WARRANTY	2 years

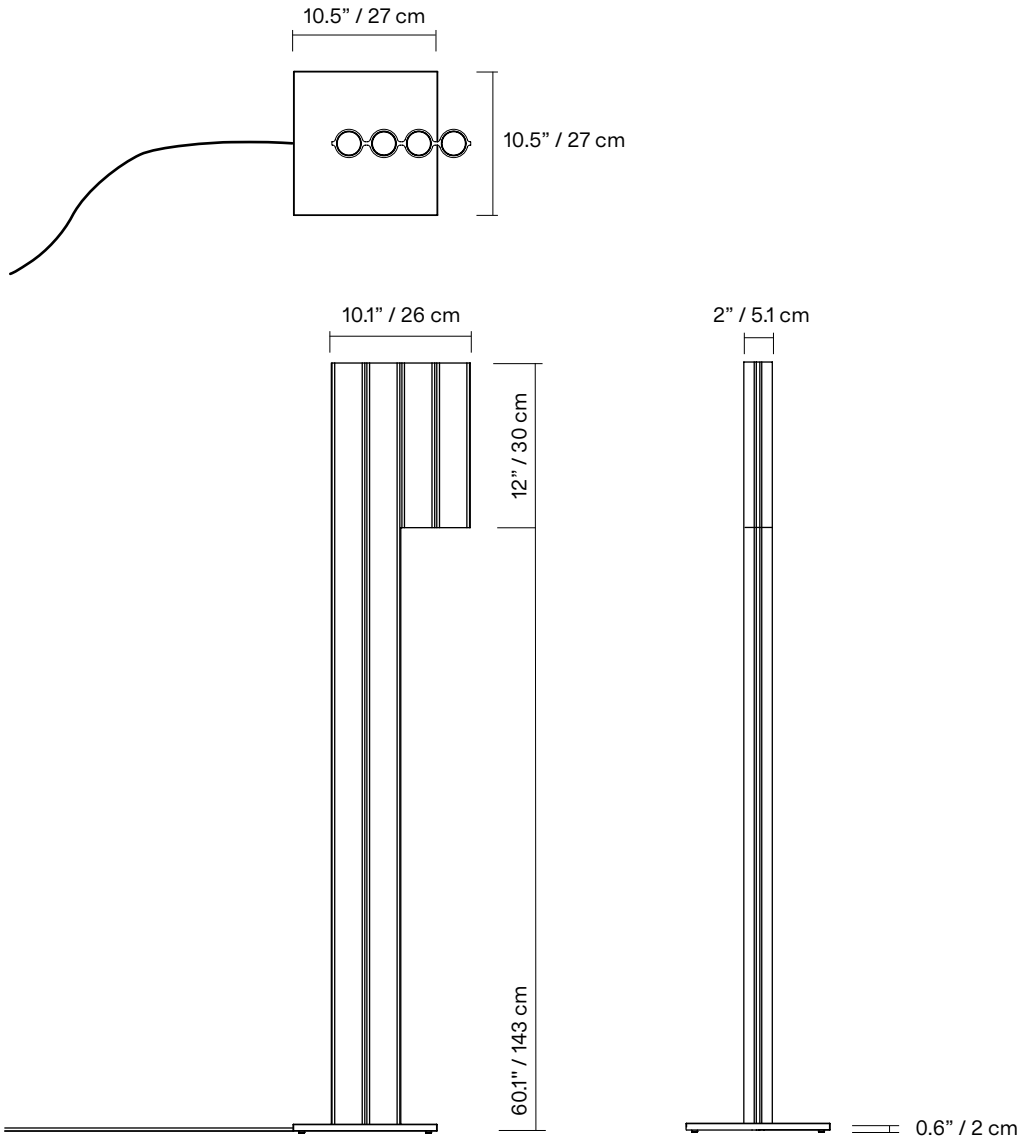

*dimensions are approximate and may vary slightly

FINISH



BK
Textured
black



WH
Textured
white



MR
Mirror
polished



BG
Textured
beige



DP
Wrinkled
dusty pink



TC
Textured
terracotta



AU
Textured
aubergine



OB
Glossy
oxblood



MB
Textured
midnight blue

CORD



BK
Black

CONFIGURATION

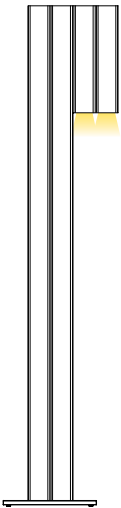

NOTES

- Not protected against liquids (refer to IP20)
- Additional charges for modifications or for special orders
- Please refer to maintenance sheet on our website for cleaning instructions

LAMP ANATOMY

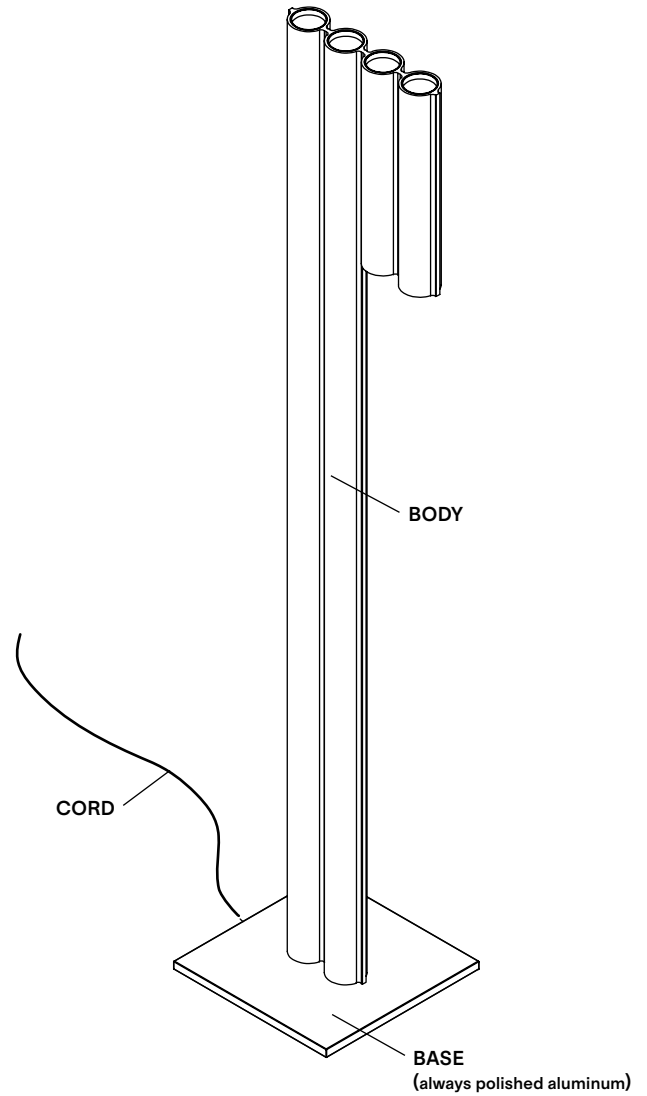

		Example	Fill with your selection
COLLECTION	SIL Silo	SIL	SIL
MODEL	4F	4F	4F
SHAPE	I	I	I
BODY	BK Textured black WH Textured white MR Mirror polished aluminum BG Textured beige DP Wrinkled dusty pink TC Textured terracotta AU Textured aubergine OB Glossy oxblood MB Textured midnight blue CC Custom colour*	BK	
CORD	BK Black	BK	BK
COLOUR TEMPERATURE (CCT)	WL Warm light (2700K) NL Neutral light (3000K) D27 Dim to warm (2700K-2200K) D30 Dim to warm (3000K-2200K) CCT Other CCT available upon request**	WL	
FULL SKU		SIL4FIBKBKWL	
		NOTES	

*Custom colour available upon request. Material library on website.

**Other CCT: 2200K, 3500K and 4000K (not available in Dim-to-Warm feature)

Silo 4T



The Silo collection inhabits many worlds at once, creating a striking metaphor for duality. Mysterious yet inviting, the true magic lies in how its rhythmic curves shape light and space around it. Made using custom aluminium extrusions, the modular uplight-downlight creates a theatrical yet sleek composition

TYPE	Table
CONSTRUCTION	Powder coated, mirror polished or tumbled aluminum body Polycarbonate lens Vinyl cord
SPECIFICATIONS	Source: LED array integrated Power consumption: 7.6W Colour temperature : 3000K 2700K dim to warm 3000K to 2200K dim to warm 2700K to 2200K Lumen output: 3000K - 456lm 2700K - 435lm Colour rendering index: ≥90 CRI Colour consistency: 3 SDCM Expected lifetime: ≥50 000h
CONTROL	100-240 VAC Plug-in Driver, cord dimmer
CORD LENGTH	96" / 244 cm provided cord dimmer positioned at 18" / 46 cm from body
WARRANTY	2 years

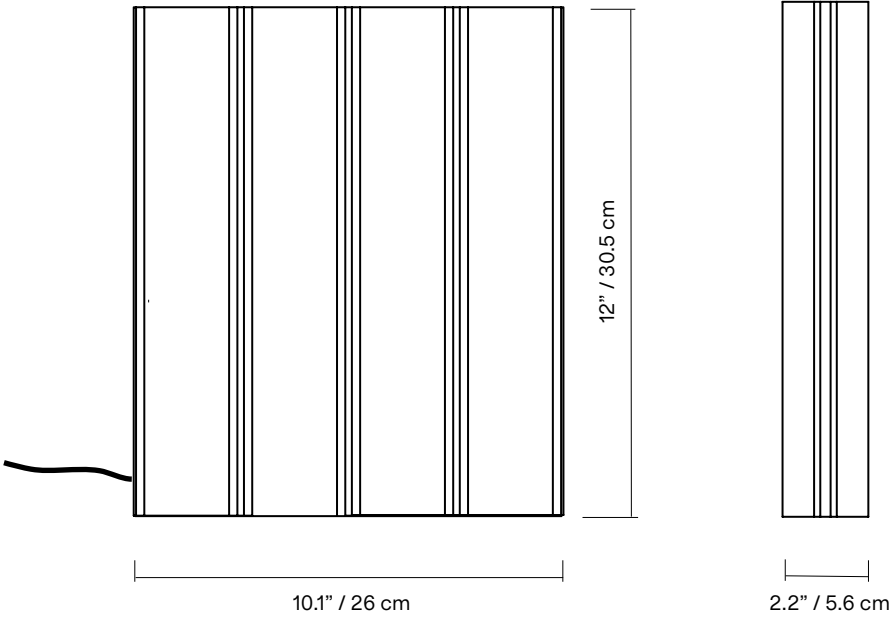

*dimensions are approximate and may vary slightly

FINISH



BK
Textured
black



WH
Textured
white



MR
Mirror
polished



TA
Tumbled
aluminum



BG
Textured
beige



DP
Wrinkled
dusty pink



TC
Textured
terracotta



AU
Textured
aubergine



OB
Glossy
oxblood



MB
Textured
midnight blue

CORD



BK
Black

NOTES

- Not protected against liquids (refer to IP20)
- Additional charges for modifications or for special orders
- Please refer to maintenance sheet on our website for cleaning instructions

LAMP ANATOMY

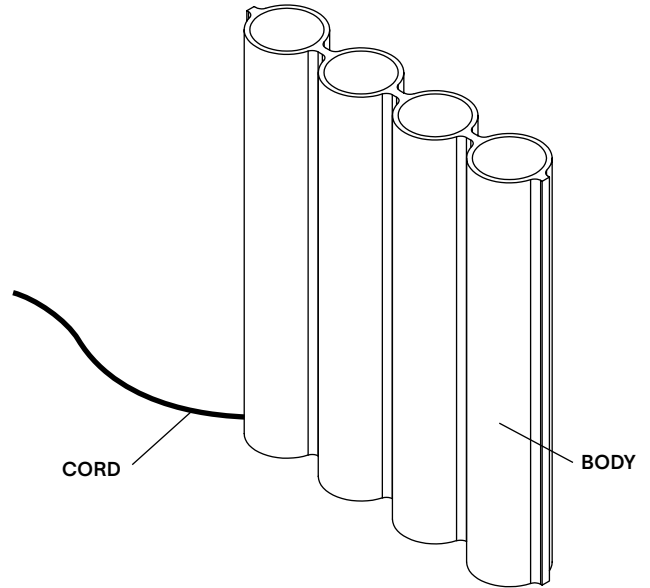

		Example	Fill with your selection
COLLECTION	SIL Silo	SIL	SIL
MODEL	4T	4T	4T
SHAPE	A	A	A
BODY	BK Textured black WH Textured white MR Mirror polished aluminum TA Tumbled aluminum BG Textured beige DP Wrinkled dusty pink TC Textured terracotta AU Textured aubergine OB Glossy oxblood MB Textured midnight blue CC Custom colour*	BK	
CORD	BK Black	BK	BK
COLOUR TEMPERATURE (CCT)	WL Warm light (2700K) NL Neutral light (3000K) D27 Dim to warm (2700K-2200K) D30 Dim to warm (3000K-2200K) CCT Other CCT available upon request**	WL	
FULL SKU		SIL4TABKBKWL	
		NOTES	

*Custom colour available upon request. Material library on website.

**Other CCT: 2200K, 3500K and 4000K (not available in Dim-to-Warm feature)