





Hutchison 01



Hutchison is the thoughtful study of soft curves and hard lines—a rivalry of vertical and horizontal forces and a play of scale and repetition. Alone, it self-defines as a frank, decorative pendant light. In multiples, it evokes the iconic patterns of Middle Eastern archways and Roman terracotta roofs

TYPE	Suspension
CONSTRUCTION	Powder coated or polished aluminum body PMMA frosted diffuser Polyester cord
SPECIFICATIONS	Source: LED array, integrated Power consumption: 7.7W Lumen output: 3000K - 625lm 2700K - 568lm Colour rendering index: ≥ 90 CRI Colour consistency: 3 SDCM Expected lifetime: $\geq 50\,000$ h
CONTROL	120/277V on/off, 0-10V, or phase dimming (120V only) 220-240V: On/Off, Phase Dimming
CORD LENGTH	108" / 275 cm
WEIGHT	1.7lbs / 0.8Kg
CERTIFICATIONS	     IP20
WARRANTY	2 years

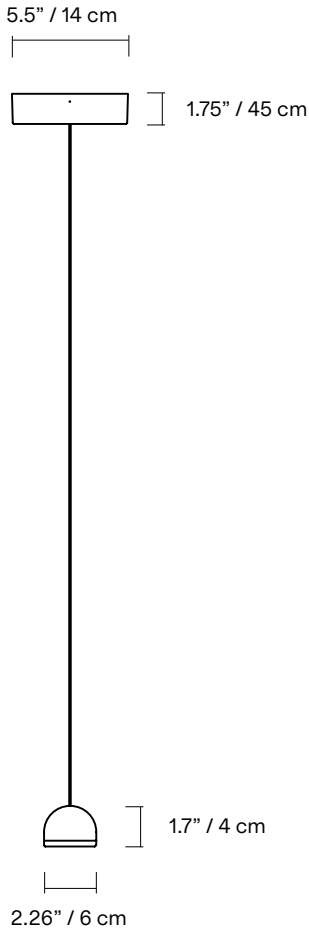
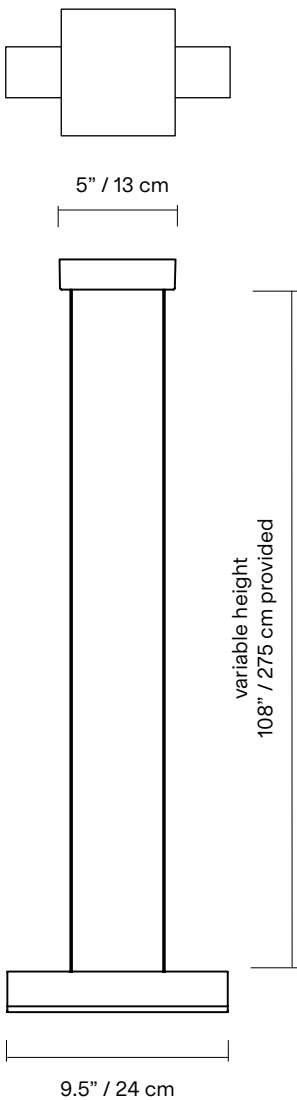

*dimensions are approximate and may vary slightly

FINISH



BK
Textured
black



WH
Textured
white



AL
Polished
aluminum



BG
Textured
beige



TC
Textured
terracotta

CORD



BK
Black



WH
White

NOTES

- Must be installed by an electrician
- LED may only be changed by Lambert & Fils or other authorized personnel
- Not protected against liquids (refer to IP20)
- Offset option available upon request
- Additional charges for modifications or for special orders
- Please refer to maintenance sheet on our website for cleaning instructions



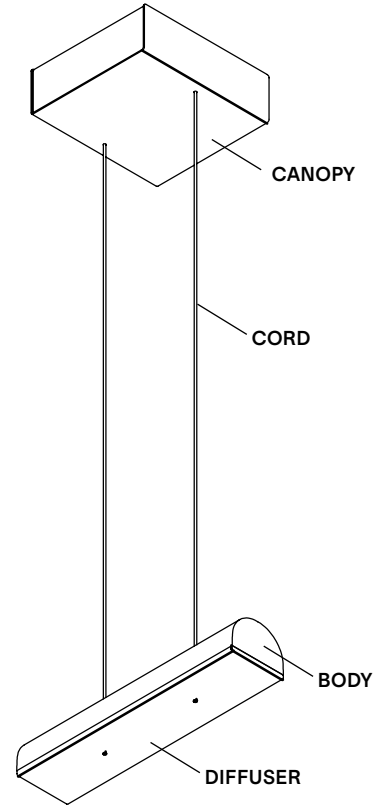

LAMP ANATOMY



Hutchison 02



Hutchison is the thoughtful study of soft curves and hard lines—a rivalry of vertical and horizontal forces and a play of scale and repetition. Alone, it self-defines as a frank, decorative pendant light. In multiples, it evokes the iconic patterns of Middle Eastern archways and Roman terracotta roofs

TYPE	Suspension
CONSTRUCTION	Powder coated or polished aluminum body PMMA frosted diffuser Polyester cord
SPECIFICATIONS	Source: LED array, integrated Power consumption: 10.7W Lumen output: 3000K - 851lm 2700K - 774lm Colour rendering index: ≥ 90 CRI Colour consistency: 3 SDCM Expected lifetime: $\geq 50\,000$ h
CONTROL	120/277V on/off, 0-10V, or phase dimming (120V only) 220-240V: On/Off, Phase Dimming
CORD LENGTH	108" / 275 cm
WEIGHT	3.4lbs / 1.6Kg
CERTIFICATIONS	     IP20
WARRANTY	2 years

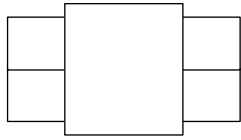

5" / 13 cm

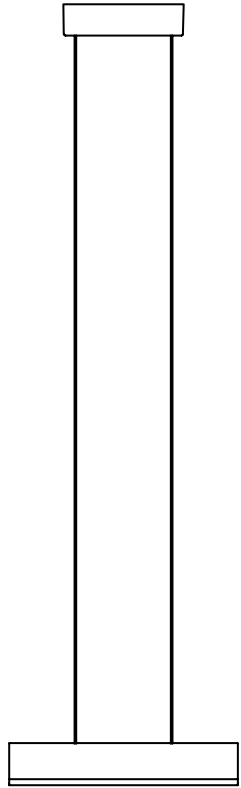

variable height
108" / 275 cm provided

9.5" / 24 cm

5.5" / 14 cm

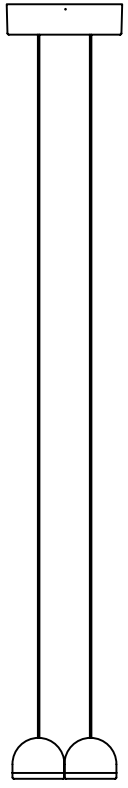

1.75" / 45 cm

1.7" / 4 cm

4.5" / 12 cm

*dimensions are approximate and may vary slightly

FINISH



BK
Textured
black



WH
Textured
white



AL
Polished
aluminum



BG
Textured
beige



TC
Textured
terracotta

CORD



BK
Black



WH
White

NOTES

- Must be installed by an electrician
- LED may only be changed by Lambert & Fils or other authorized personnel
- Not protected against liquids (refer to IP20)
- Offset option available upon request
- Additional charges for modifications or for special orders
- Please refer to maintenance sheet on our website for cleaning instructions



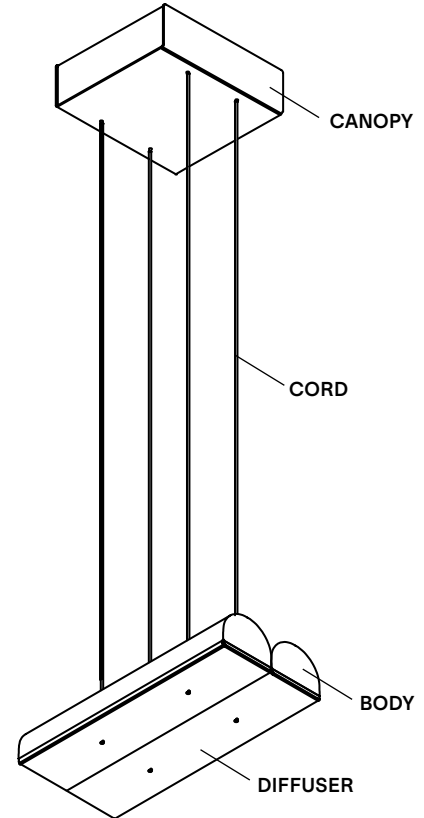

LAMP ANATOMY



Hutchison 03



Hutchison is the thoughtful study of soft curves and hard lines—a rivalry of vertical and horizontal forces and a play of scale and repetition. Alone, it self-defines as a frank, decorative pendant light. In multiples, it evokes the iconic patterns of Middle Eastern archways and Roman terracotta roofs

TYPE	Suspension
CONSTRUCTION	Powder coated or polished aluminum body PMMA frosted diffuser Polyester cord
SPECIFICATIONS	Source: LED array, integrated Power consumption: 15W Lumen output: 3000K - 1180lm 2700K - 1073lm Colour rendering index: ≥ 90 CRI Colour consistency: 3 SDCM Expected lifetime: $\geq 50\,000$ h
CONTROL	120/277V on/off, 0-10V, or phase dimming (120V only) 220-240V: On/Off, Phase Dimming
CORD LENGTH	108" / 275 cm
WEIGHT	5.1lbs / 2.4Kg
CERTIFICATIONS	     IP20
WARRANTY	2 years

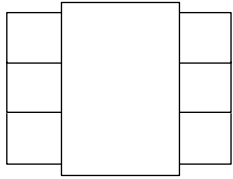

5" / 13 cm

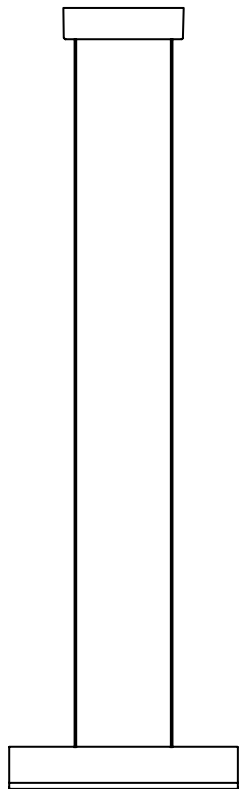

9.5" / 24 cm

variable height
108" / 275 cm provided

7.75" / 20 cm

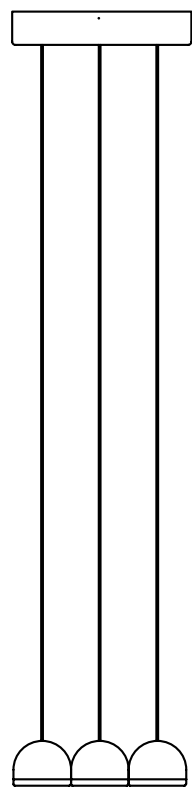

1.75" / 45 cm

1.7" / 4 cm

6.8" / 18 cm

*dimensions are approximate and may vary slightly

FINISH



BK
Textured
black



WH
Textured
white



AL
Polished
aluminum



BG
Textured
beige



TC
Textured
terracotta

CORD



BK
Black



WH
White

NOTES

- Must be installed by an electrician
- LED may only be changed by Lambert & Fils or other authorized personnel
- Not protected against liquids (refer to IP20)
- Offset option available upon request
- Additional charges for modifications or for special orders
- Please refer to maintenance sheet on our website for cleaning instructions



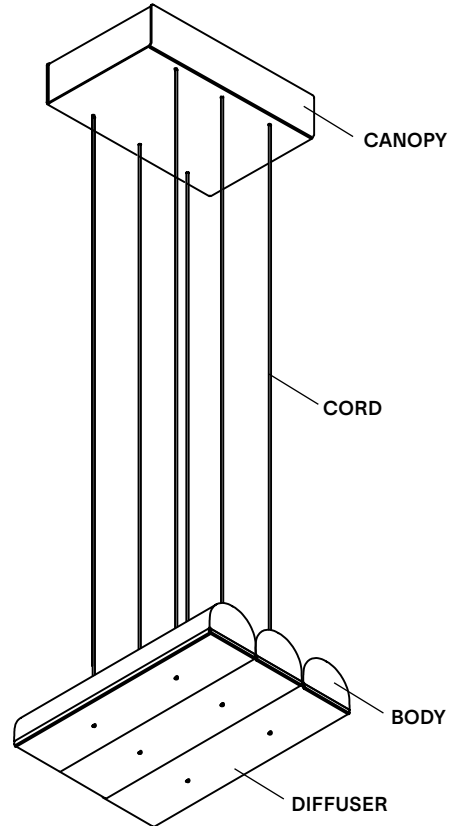

LAMP ANATOMY



Hutchison 04



Hutchison is the thoughtful study of soft curves and hard lines—a rivalry of vertical and horizontal forces and a play of scale and repetition. Alone, it self-defines as a frank, decorative pendant light. In multiples, it evokes the iconic patterns of Middle Eastern archways and Roman terracotta roofs

TYPE	Suspension
CONSTRUCTION	Powder coated or polished aluminum body PMMA frosted diffuser Polyester cord
SPECIFICATIONS	Source: LED array, integrated Power consumption: 21W Lumen output: 3000K - 1602lm 2700K - 1457lm Colour rendering index: ≥ 90 CRI Colour consistency: 3 SDCM Expected lifetime: $\geq 50\ 000$ h
CONTROL	120/277V on/off, 0-10V, or phase dimming (120V only) 220-240V: On/Off, Phase Dimming
CORD LENGTH	108" / 275 cm
WEIGHT	6.8lbs / 3.2Kg
CERTIFICATIONS	     IP20
WARRANTY	2 years

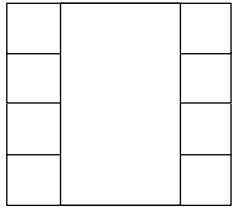

5" / 13 cm



7.75" / 20 cm

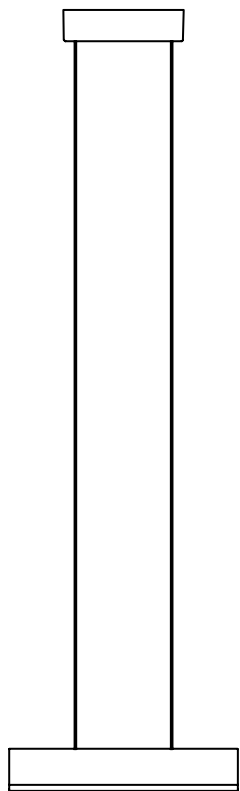

variable height
108" / 275 cm provided

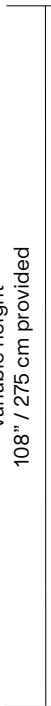

9.5" / 24 cm

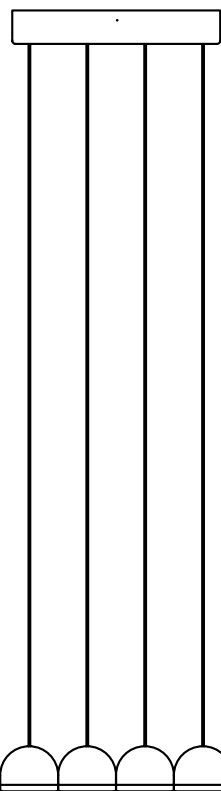

1.75" / 45 cm



1.7" / 4 cm



9" / 24 cm



*dimensions are approximate and may vary slightly

FINISH



BK
Textured
black



WH
Textured
white



AL
Polished
aluminum



BG
Textured
beige



TC
Textured
terracotta

CORD



BK
Black



WH
White

NOTES

- Must be installed by an electrician
- LED may only be changed by Lambert & Fils or other authorized personnel
- Not protected against liquids (refer to IP20)
- Offset option available upon request
- Additional charges for modifications or for special orders
- Please refer to maintenance sheet on our website for cleaning instructions

LAMP ANATOMY

