







DORVAL 04

Based on SCMP DESIGN OFFICE's original pendant prototype Dorval 01, this collection is layered in history, a subtle interplay between contemporary and vintage industrial design. Drawing equal inspiration from airport runway lights and the classic Motobecane french moped, the result is a light both confrontational and intriguing—one which poses an immediate invitation to play.

- type:** wall, hardwire version
- construction:** powder coated or polished aluminum body and head
clear prismatic PMMA lens
- specifications:** source: LED array, integrated
power consumption: 5W
color temperature: 3000K
2700K
dim to warm 3000k to 2200k
dim to warm 2700k to 2200k
lumen output: 3000K - 402 lm
colour rendering index: ≥ 90 CRI
colour consistency: 3 SDCM
expected lifetime: $\geq 50\ 000$ h
- control:** 120/277VAC On/Off, 0-10V or Phase Dimming (120V only)
220-240VAC On/Off, Phase Dimming, DALI
refer to our recommended list of dimmer models
- certifications:**     IP20
- warranty:** 2 years

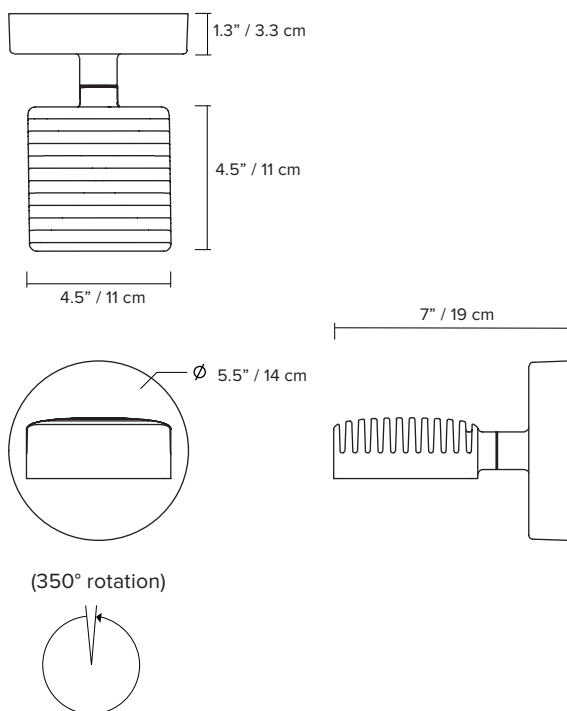

ORDER GUIDE: SKU

COLLECTION		MODEL	INSTALLATION		FINISH	COLOUR TEMPERATURE (CCT)		DIMMING		
DOR	dorval	04	HW	hardwire	BK	black	WL	warm light (2700K)	ZT	0-10V dimming
					WH	white	NL	neutral light (3000K)	PH	phase dimming
					MB	midnight blue	D27	dim to warm (2700K-2200K)	DA	DALI
					LB	light blue	D30	dim to warm (3000K-2200K)		
					BG	beige	CCT	other CCT available upon request *		
					AL	aluminum				
DOR		04	HW		BK		WL		ZT	= DOR04HWBKWLZT
										example

* Specific CCT selection only available in 100K increments, from 2200K to 4000K inclusively. Not available with Dim-to-Warm feature.

FINISH

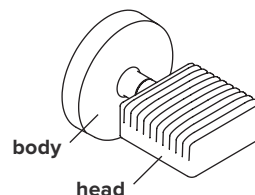
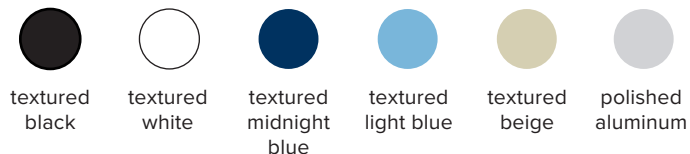

NOTES:

- must be installed by an electrician
- LED may only be changed by Lambert & Fils or other authorized personnel
- not protected against liquids (refer to IP20)
- additional charges for modifications or for special orders
- please refer to maintenance sheet on our website for cleaning instructions

DIMMER SPECIFICATIONS

TESTED DIMMER COMPATIBILITY LIST - 120V*

Phase cut dimming (leading edge or trailing edge**)

Dimmer brand	Model	Max level	Min level	Dimming Protocol
Cooper/Eaton	DAL06P	100%	0%	Phase Cut
Cooper/Eaton	DLC03P	100%	0%	Phase Cut
Cooper/Eaton	SLC03P	100%	4%	Phase Cut
Leviton	IPE04-1LZ	100%	5%	Phase Cut
Leviton	IPI06-1LZ	100%	0%	Phase Cut
Leviton	VPE06-1LZ	100%	7%	Phase Cut
Lutron	DVCL-153P	100%	0%	Phase Cut
Lutron	DVELV-303P	100%	4%	Phase Cut
Lutron	FAELV-500	100%	10%	Phase Cut
Lutron	MAELV-600	100%	9%	Phase Cut
Lutron	SELV-300P	100%	5%	Phase Cut
Lutron	TGCL-153P	100%	4%	Phase Cut

TESTED DIMMER COMPATIBILITY LIST - 230V*

Phase cut dimming (leading edge or trailing edge**)

Dimmer brand	Model	Max level	Min level	Dimming Protocol
Busch-Jaeger	6523U	100%	0.1%	Phase Cut
CLIPSAL	32E450TM	100%	3.0%	Phase Cut
Dignet	MEDM	100%	0.0%	Phase Cut
Dignet	MMDM/PB	100%	0.0%	Phase Cut
ELKO	315GLE	100%	1.7%	Phase Cut
Finder	15.91.8	100%	1.8%	Phase Cut
Gira	117600/I01	100%	0.1%	Phase Cut

Some dimmers require a minimum load, check specifications.

*Other dimmers that specify LED lamp compatibility may operate without issue.

We recommend conducting your own test before final installation.

**Leading edge is also known as TRIAC or Forward Phase.

Trailing edge is also known as ELV or Reverse Phase.

EU ENERGY LABEL

