





Sainte 01



Featuring lightweight glass panels, the Sainte's Classic series is destined for residential, hospitality and office interiors. Hung solo or in multiples, Sainte's tones and textures unearth ambiance and imbue a sense of intimacy. A removable aluminum lightbox rests within the translucent glass and can be flipped around, allowing it to cast light up or down.

Created in collaboration with Canadian designer Rachel Bussin.

TYPE	Suspension
CONSTRUCTION	Aluminum polished light block, glass anchor system and ceiling anchors Polyester laminated glass Nylon ribbon PMMA frosted diffuser
SPECIFICATIONS	Source: LED array, integrated Power consumption: 19.3W Colour temperature: 3000K 2700K dim to warm 3000K to 2200K dim to warm 2700K to 2200K Lumen output: 2700K - 927lm Colour rendering index: ≥ 90 CRI Colour consistency: 3 SDCM Expected lifetime: $\geq 50\ 000$ h
CONTROL	120-277V: On/Off, 0-10V, Phase Dimming (120V only) 220-240V: On/Off, Phase Dimming, DALI Refer to our recommended list of dimmer models
CORD LENGTH	10' / 305 cm each side, width: 1.5" / 3.8 cm
WEIGHT	14.3 lb / 6.5 kg
CERTIFICATIONS	     IP20
WARRANTY	2 years

NOTES

- Luminaire total minimum height (ceiling to lowest point of luminaire) - 12" / 31 cm
- Luminaire Total maximum height (ceiling to lowest point of luminaire) - 126" / 320 cm, contact Lambert & Fils for more options
- Luminaire height is adjustable on site
- For slanted ceiling contact Lambert & Fils

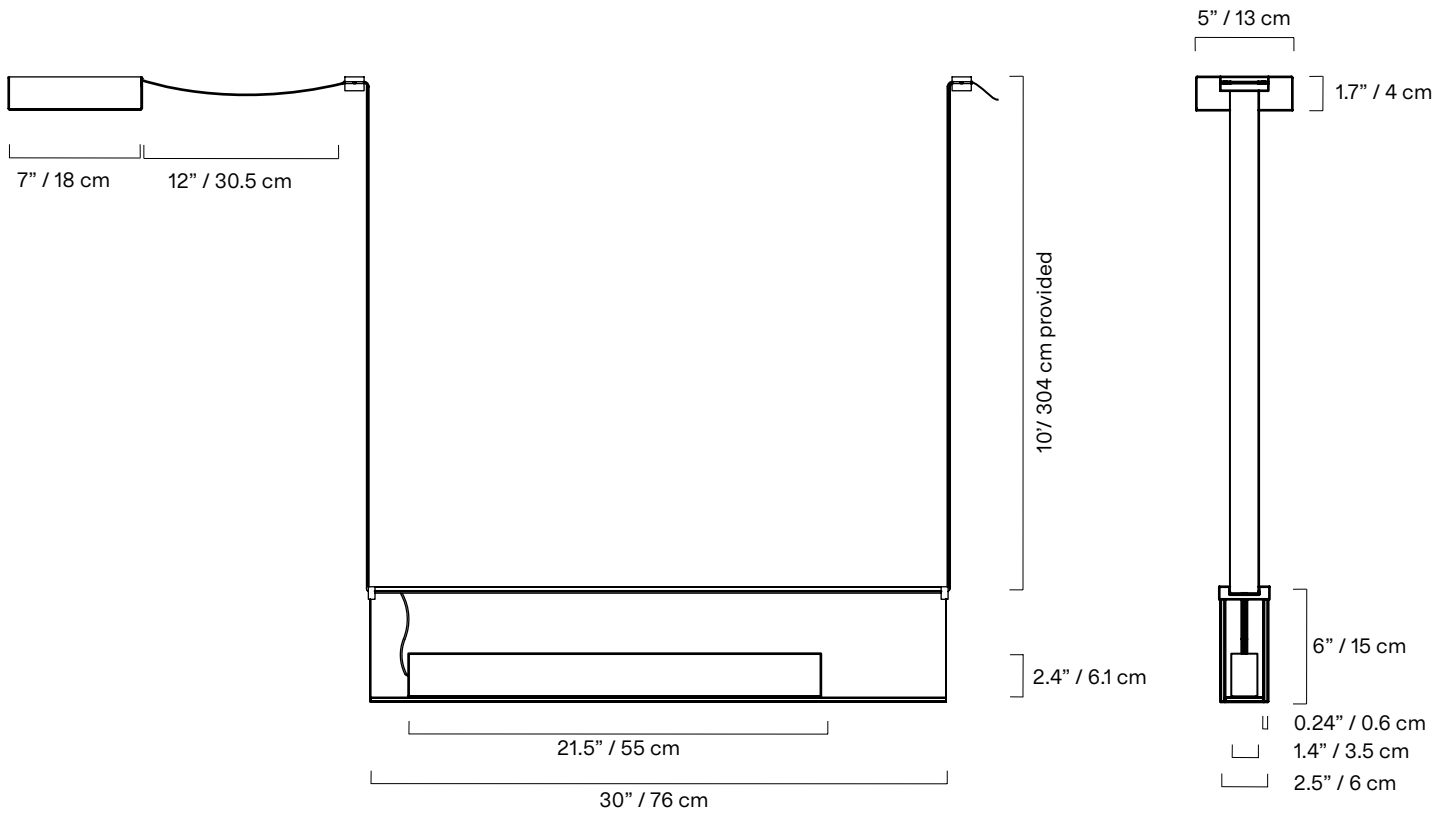

*dimensions are approximate and may vary slightly

GLASS BODY

(*Custom colours available on one or both sides upon request)

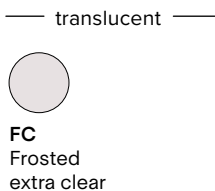
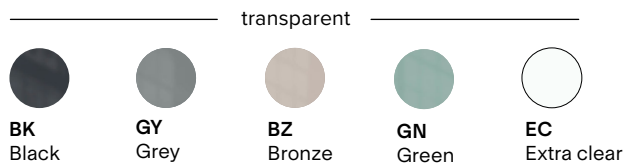

NYLON RIBBON

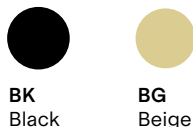

MOUNTING OPTIONS

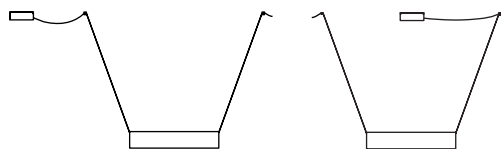

Must be installed at 20 degrees or less.

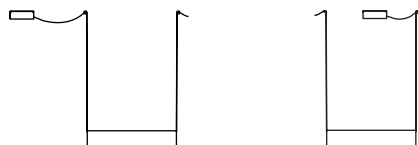

NOTES

- Must be installed by an electrician
- LED may only be changed by Lambert & Fils or other authorized personnel
- Not protected against liquids (refer to IP20)
- Additional charges for modifications or for special orders
- Please refer to maintenance sheet on our website for cleaning instructions

LAMP ANATOMY

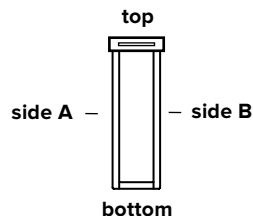
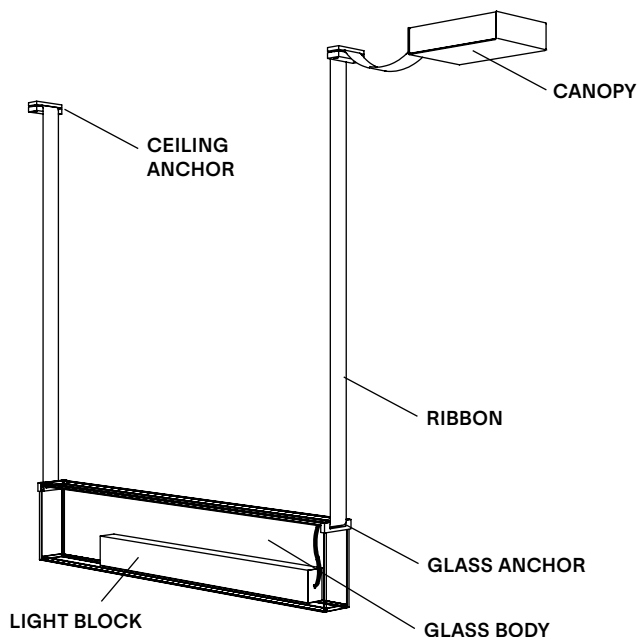

Top and bottom are always ultraclear and not available in colour

		Example	Fill with your selection
COLLECTION	STE Sainte	STE	STE
MODEL	01	01	01
COLOUR SIDE A	BK Black BZ Bronze EC Extra clear FC Frosted extra clear GN Green GY Grey PL Plum RU Ruby CC Custom colour*	BK	
COLOUR SIDE B	BK Black BZ Bronze EC Extra clear FC Frosted extra clear GN Green GY Grey PL Plum RU Ruby CC Custom colour*	BK	
NYLON RIBBON	BK Black BG Beige	BK	
CANOPY	BK Black WH White	BK	
COLOUR TEMPERATURE (CCT)	WL Warm light (2700K) NL Neutral light (3000K) D27 Dim to warm (2700K-2200K) D30 Dim to warm (3000K-2200K) CCT Other CCT available upon request**	WL	
DIMMING	ZT 0-10V (120VAC only) PH Phase dimming DA DALI (220-240VAC only)	ZT	
FULL SKU		STE01BKBKKBKWLZT	
		NOTES	

* Other colours available upon request. Material library on website.





**Specific CCT selection only available in 100k increments, from 2200K to 4000K inclusively and not available with Dim-to-Warm feature.

Sainte 02



Featuring lightweight glass panels, the Sainte's Classic series is destined for residential, hospitality and office interiors. Hung solo or in multiples, Sainte's tones and textures unearth ambiance and imbue a sense of intimacy. A removable aluminum lightbox rests within the translucent glass and can be flipped around, allowing it to cast light up or down.

Created in collaboration with Canadian designer Rachel Bussin.

TYPE	Suspension
CONSTRUCTION	Aluminum polished light block, glass anchor system and ceiling anchors Polyester laminated glass Nylon ribbon PMMA frosted diffuser
SPECIFICATIONS	Source: LED array, integrated Power consumption: 11W Colour temperature: 3000K 2700K dim to warm 3000K to 2200K dim to warm 2700K to 2200K Lumen output: 2700K - 499lm Colour rendering index: ≥90 CRI Colour consistency: 3 SDCM Expected lifetime: ≥50 000h
CONTROL	120-277V: On/Off, 0-10V, Phase Dimming (120V only) 220-240V: On/Off, Phase Dimming, DALI Refer to our recommended list of dimmer models
CORD LENGTH	10' / 305 cm each side, width: 1.5" / 3.8 cm
WEIGHT	21.7 lb / 9.8 kg
CERTIFICATIONS	     IP20
WARRANTY	2 years

NOTES

- Luminaire total minimum height (ceiling to lowest point of luminaire) - 24.5" / 61 cm
- Luminaire Total maximum height (ceiling to lowest point of luminaire) - 138.5" / 351 cm, contact Lambert & Fils for more options
- Luminaire height is adjustable on site
- For slanted ceiling contact Lambert & Fils

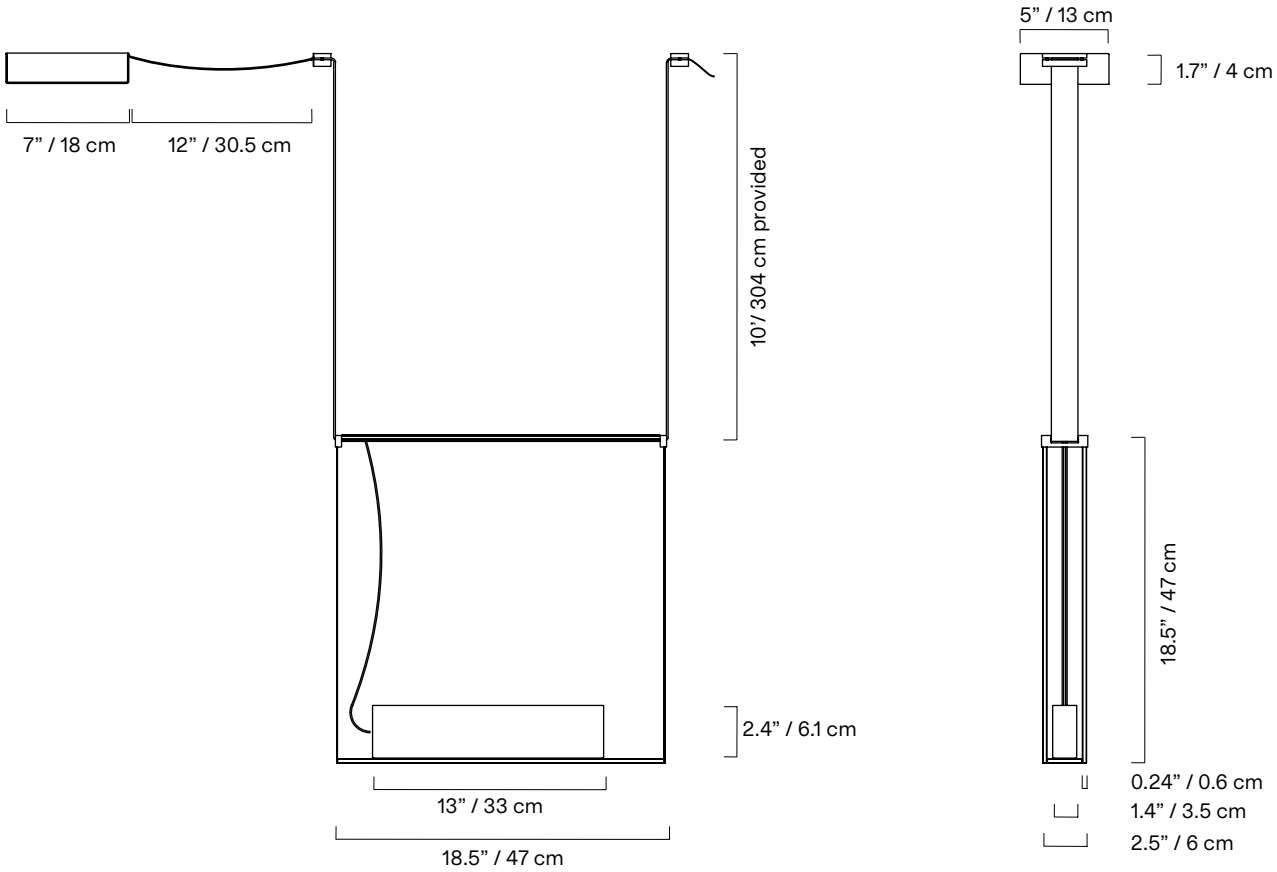

*dimensions are approximate and may vary slightly

GLASS BODY

(*Custom colours available on one or both sides upon request)

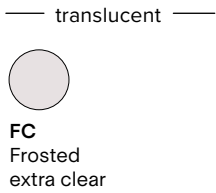
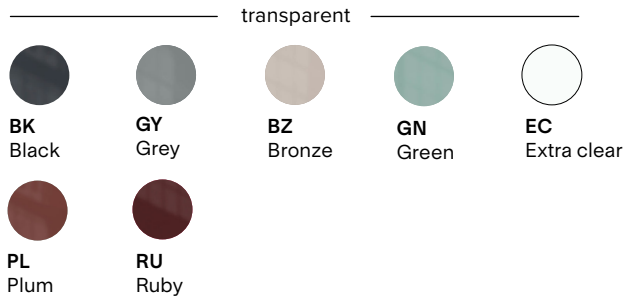

NYLON RIBBON

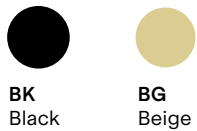

MOUNTING OPTIONS

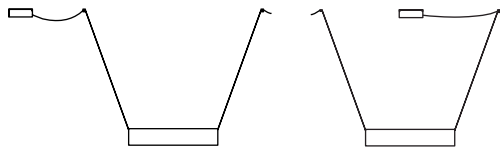

Must be installed at 20 degrees or less.

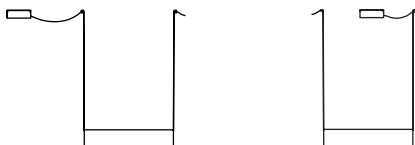

NOTES

- Must be installed by an electrician
- LED may only be changed by Lambert & Fils or other authorized personnel
- Not protected against liquids (refer to IP20)
- Additional charges for modifications or for special orders
- Please refer to maintenance sheet on our website for cleaning instructions

LAMP ANATOMY

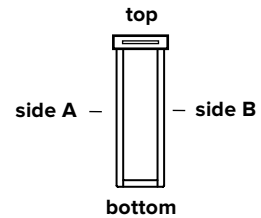
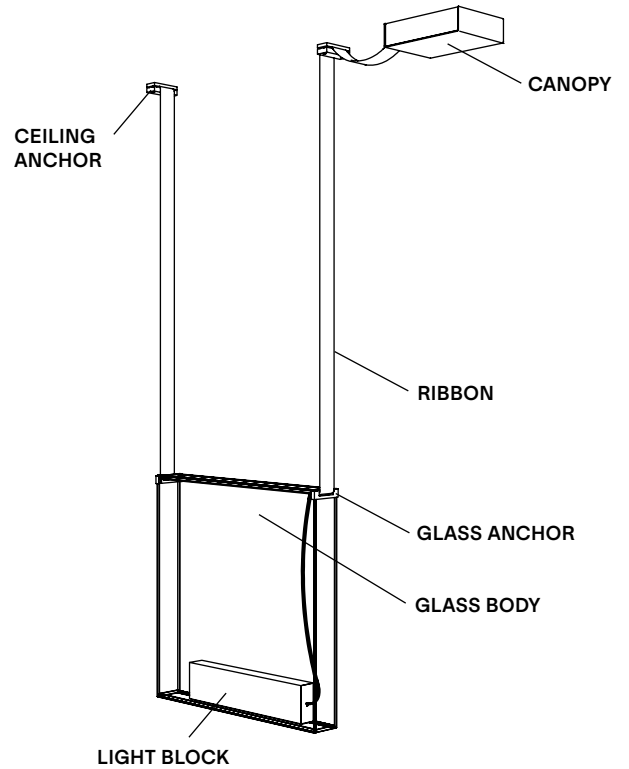

Top and bottom are always ultraclear and not available in colour

		Example	Fill with your selection
COLLECTION	STE Sainte	STE	STE
MODEL	02	02	02
COLOUR SIDE A	BK Black BZ Bronze EC Extra clear FC Frosted extra clear GN Green GY Grey PL Plum RU Ruby CC Custom colour*	BK	
COLOUR SIDE B	BK Black BZ Bronze EC Extra clear FC Frosted extra clear GN Green GY Grey PL Plum RU Ruby CC Custom colour*	BK	
NYLON RIBBON	BK Black BG Beige	BK	
CANOPY	BK Black WH White	BK	
COLOUR TEMPERATURE (CCT)	WL Warm light (2700K) NL Neutral light (3000K) D27 Dim to warm (2700K-2200K) D30 Dim to warm (3000K-2200K) CCT Other CCT available upon request**	WL	
DIMMING	ZT 0-10V (120VAC only) PH Phase dimming DA DALI (220-240VAC only)	ZT	
FULL SKU		STE02BKBKKBKWLZT	
		NOTES	

* Other colours available upon request. Material library on website.





**Specific CCT selection only available in 100k increments, from 2200K to 4000K inclusively and not available with Dim-to-Warm feature.

Sainte 03



Featuring lightweight glass panels, the Sainte's Classic series is destined for residential, hospitality and office interiors. Hung solo or in multiples, Sainte's tones and textures unearth ambiance and imbue a sense of intimacy. A removable aluminum lightbox rests within the translucent glass and can be flipped around, allowing it to cast light up or down.

Created in collaboration with Canadian designer Rachel Bussin.

TYPE	Suspension
CONSTRUCTION	Aluminum polished light block, glass anchor system and ceiling anchors Polyester laminated glass Nylon ribbon PMMA frosted diffuser
SPECIFICATIONS	Source: LED array, integrated Power consumption: 7.9W Colour temperature: 3000K 2700K dim to warm 3000K to 2200K dim to warm 2700K to 2200K Lumen output: 2700K - 359lm Colour rendering index: ≥90 CRI Colour consistency: 3 SDCM Expected lifetime: ≥50 000h
CONTROL	120-277V: On/Off, 0-10V, Phase Dimming (120V only) 220-240V: On/Off, Phase Dimming, DALI Refer to our recommended list of dimmer models
CORD LENGTH	10' / 305 cm each side, width: 1.5" / 3.8 cm
WEIGHT	18.3 lb / 8.2 kg
CERTIFICATIONS	     IP20
WARRANTY	2 years

NOTES

- Luminaire total minimum height (ceiling to lowest point of luminaire) - 28" / 71 cm
- Luminaire Total maximum height (ceiling to lowest point of luminaire) - 142" / 361 cm, contact Lambert & Fils for more options
- Luminaire height is adjustable on site
- For slanted ceiling contact Lambert & Fils

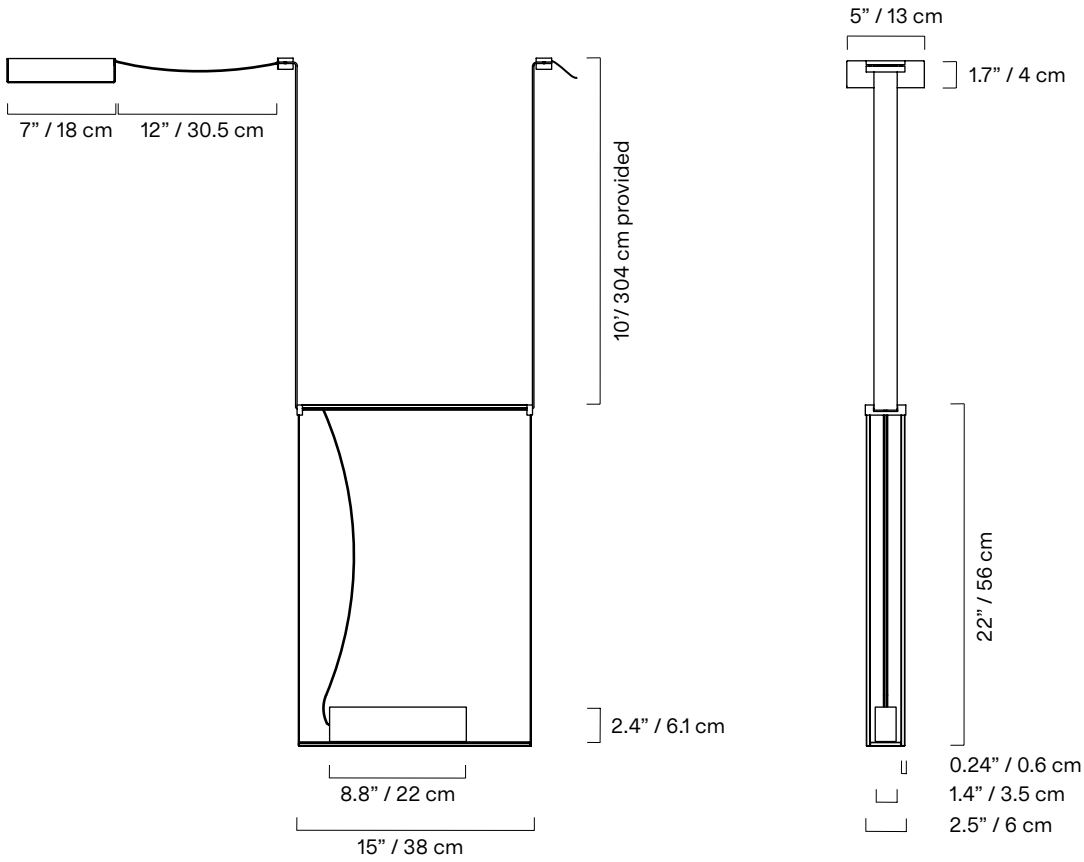

*dimensions are approximate and may vary slightly

GLASS BODY

(*Custom colours available on one or both sides upon request)

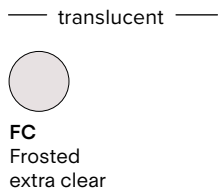
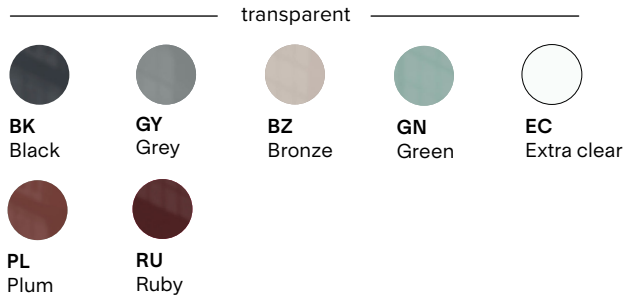

NYLON RIBBON

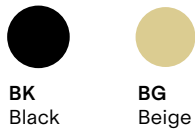

MOUNTING OPTIONS

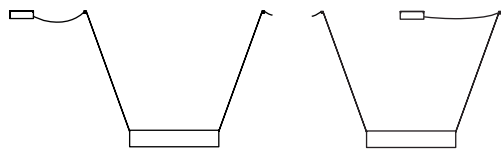

Must be installed at 20 degrees or less.

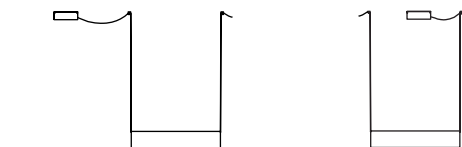

NOTES

- Must be installed by an electrician
- LED may only be changed by Lambert & Fils or other authorized personnel
- Not protected against liquids (refer to IP20)
- Additional charges for modifications or for special orders
- Please refer to maintenance sheet on our website for cleaning instructions

LAMP ANATOMY

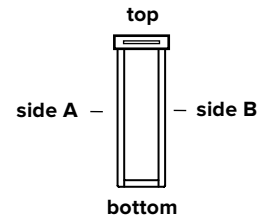
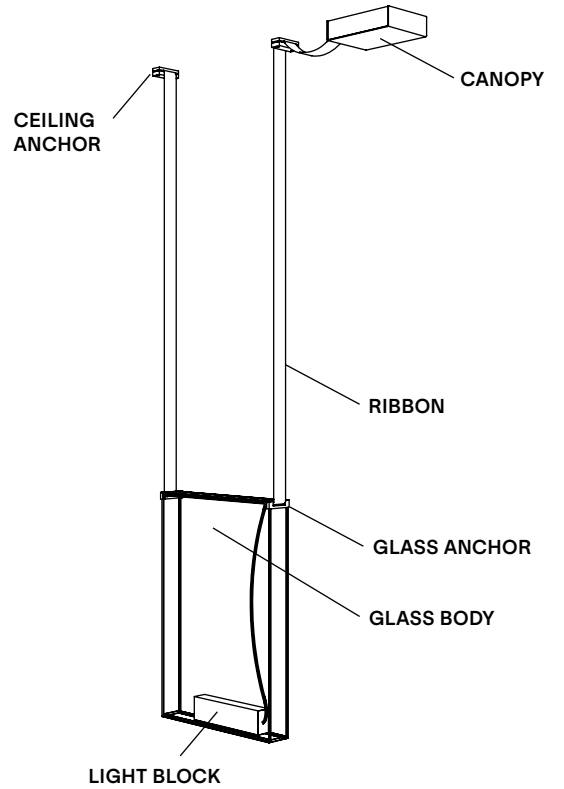

Top and bottom are always ultraclear and not available in colour

		Example	Fill with your selection
COLLECTION	STE Sainte	STE	STE
MODEL	03	03	03
COLOUR SIDE A	BK Black BZ Bronze EC Extra clear FC Frosted extra clear GN Green GY Grey PL Plum RU Ruby CC Custom colour*	BK	
COLOUR SIDE B	BK Black BZ Bronze EC Extra clear FC Frosted extra clear GN Green GY Grey PL Plum RU Ruby CC Custom colour*	BK	
NYLON RIBBON	BK Black BG Beige	BK	
CANOPY	BK Black WH White	BK	
COLOUR TEMPERATURE (CCT)	WL Warm light (2700K) NL Neutral light (3000K) D27 Dim to warm (2700K-2200K) D30 Dim to warm (3000K-2200K) CCT Other CCT available upon request**	WL	
DIMMING	ZT 0-10V (120VAC only) PH Phase dimming DA DALI (220-240VAC only)	ZT	
FULL SKU		STE03BKBKKBKWLZT	
		NOTES	

* Other colours available upon request. Material library on website.





**Specific CCT selection only available in 100k increments, from 2200K to 4000K inclusively and not available with Dim-to-Warm feature.

Sainte 05



Featuring lightweight glass panels, the Sainte's Classic series is destined for residential, hospitality and office interiors. Hung solo or in multiples, Sainte's tones and textures unearth ambiance and imbue a sense of intimacy. A removable aluminum lightbox rests within the translucent glass and can be flipped around, allowing it to cast light up or down.

Created in collaboration with Canadian designer Rachel Bussin.

TYPE	Suspension
CONSTRUCTION	Aluminum polished light block, glass anchor system and ceiling anchors Polyester laminated glass Nylon ribbon PMMA frosted diffuser
SPECIFICATIONS	Source: LED array, integrated Power consumption: 11W Colour temperature: 3000K 2700K dim to warm 3000K to 2200K dim to warm 2700K to 2200K Lumen output: 2700K - 499lm Colour rendering index: ≥90 CRI Colour consistency: 3 SDCM Expected lifetime: ≥50 000h
CONTROL	120-277V: On/Off, 0-10V, Phase Dimming (120V only) 220-240V: On/Off, Phase Dimming, DALI Refer to our recommended list of dimmer models
CORD LENGTH	10' / 305 cm each side, width: 1.5" / 3.8 cm
WEIGHT	15.1 lb / 6.8 kg
CERTIFICATIONS	     IP20
WARRANTY	2 years

NOTES

- Luminaire total minimum height (ceiling to lowest point of luminaire) - 15" / 38 cm
- Luminaire Total maximum height (ceiling to lowest point of luminaire) - 129" / 328 cm, contact Lambert & Fils for more options
- Luminaire height is adjustable on site
- For slanted ceiling contact Lambert & Fils

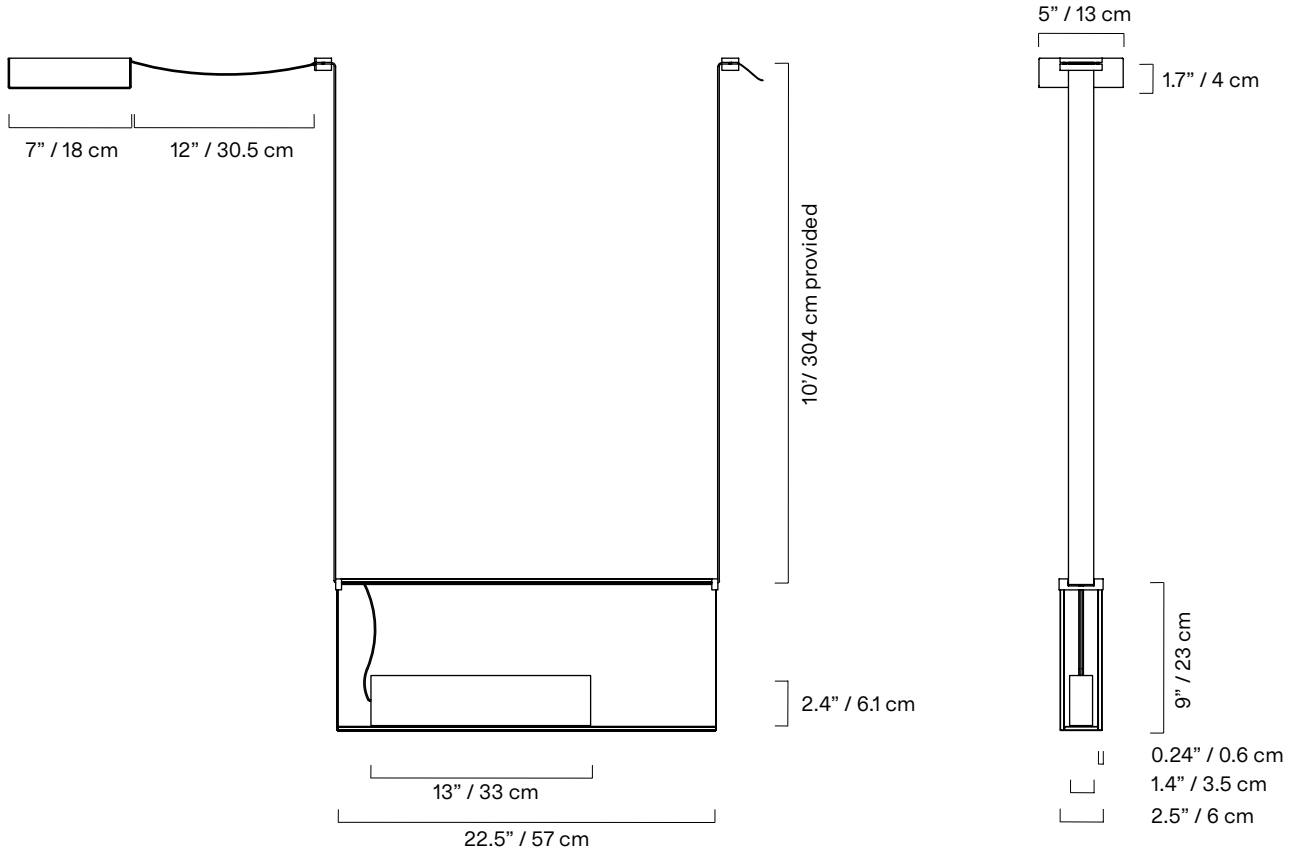

*dimensions are approximate and may vary slightly

GLASS BODY

(*Custom colours available on one or both sides upon request)

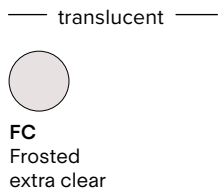
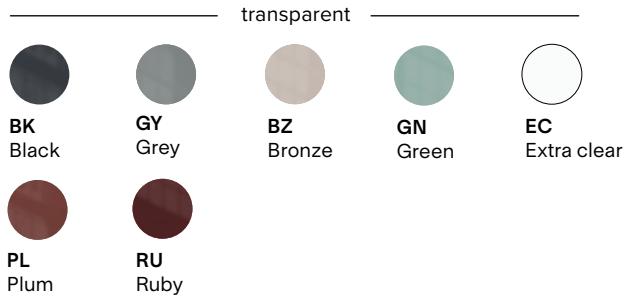

NYLON RIBBON

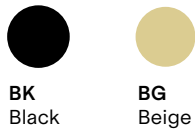

MOUNTING OPTIONS

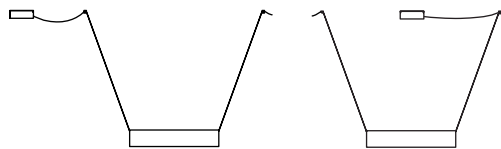

Must be installed at 20 degrees or less.

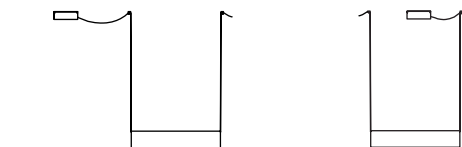

NOTES

- Must be installed by an electrician
- LED may only be changed by Lambert & Fils or other authorized personnel
- Not protected against liquids (refer to IP20)
- Additional charges for modifications or for special orders
- Please refer to maintenance sheet on our website for cleaning instructions

LAMP ANATOMY

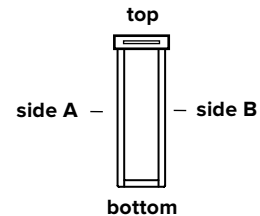
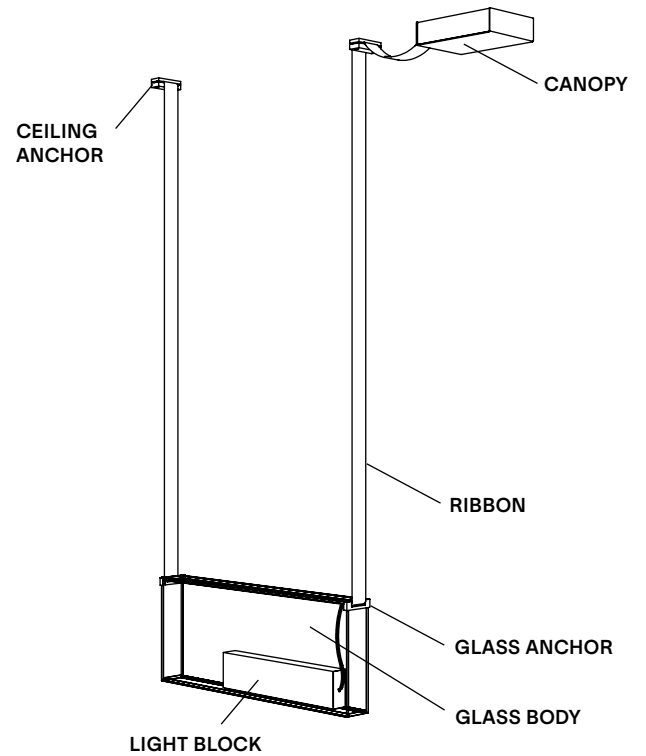

Top and bottom are always ultraclear and not available in colour

		Example	Fill with your selection
COLLECTION	STE Sainte	STE	STE
MODEL	05	05	05
COLOUR SIDE A	BK Black BZ Bronze EC Extra clear FC Frosted extra clear GN Green GY Grey PL Plum RU Ruby CC Custom colour*	BK	
COLOUR SIDE B	BK Black BZ Bronze EC Extra clear FC Frosted extra clear GN Green GY Grey PL Plum RU Ruby CC Custom colour*	BK	
NYLON RIBBON	BK Black BG Beige	BK	
CANOPY	BK Black WH White	BK	
COLOUR TEMPERATURE (CCT)	WL Warm light (2700K) NL Neutral light (3000K) D27 Dim to warm (2700K-2200K) D30 Dim to warm (3000K-2200K) CCT Other CCT available upon request**	WL	
DIMMING	ZT 0-10V (120VAC only) PH Phase dimming DA DALI (220-240VAC only)	ZT	
FULL SKU		STE05BKBKKBKWLZT	
		NOTES	

* Other colours available upon request. Material library on website.





**Specific CCT selection only available in 100k increments, from 2200K to 4000K inclusively and not available with Dim-to-Warm feature.

Sainte 06



Featuring lightweight glass panels, the Sainte's Classic series is destined for residential, hospitality and office interiors. Hung solo or in multiples, Sainte's tones and textures unearth ambiance and imbue a sense of intimacy. A removable aluminum lightbox rests within the translucent glass and can be flipped around, allowing it to cast light up or down.

Created in collaboration with Canadian designer Rachel Bussin.

TYPE	Suspension
CONSTRUCTION	Aluminum polished light block, glass anchor system and ceiling anchors Polyester laminated glass Nylon ribbon PMMA frosted diffuser
SPECIFICATIONS	Source: LED array, integrated Power consumption: 26.8W Colour temperature: 3000K 2700K dim to warm 3000K to 2200K dim to warm 2700K to 2200K Lumen output: 2700K - 499lm Colour rendering index: ≥90 CRI Colour consistency: 3 SDCM Expected lifetime: ≥50 000h
CONTROL	120-277V: On/Off, 0-10V, Phase Dimming (120V only) 220-240V: On/Off, Phase Dimming, DALI Refer to our recommended list of dimmer models
CORD LENGTH	10" / 305 cm each side, width: 2" / 5 cm
WEIGHT	41.8 lb / 18.6 kg
CERTIFICATIONS	     IP20
WARRANTY	2 years

NOTES

- Luminaire total minimum height (ceiling to lowest point of luminaire) - 14" / 61 cm
- Luminaire Total maximum height (ceiling to lowest point of luminaire) - 128" / 325 cm, contact Lambert & Fils for more options
- Luminaire height is adjustable on site
- For slanted ceiling contact Lambert & Fils

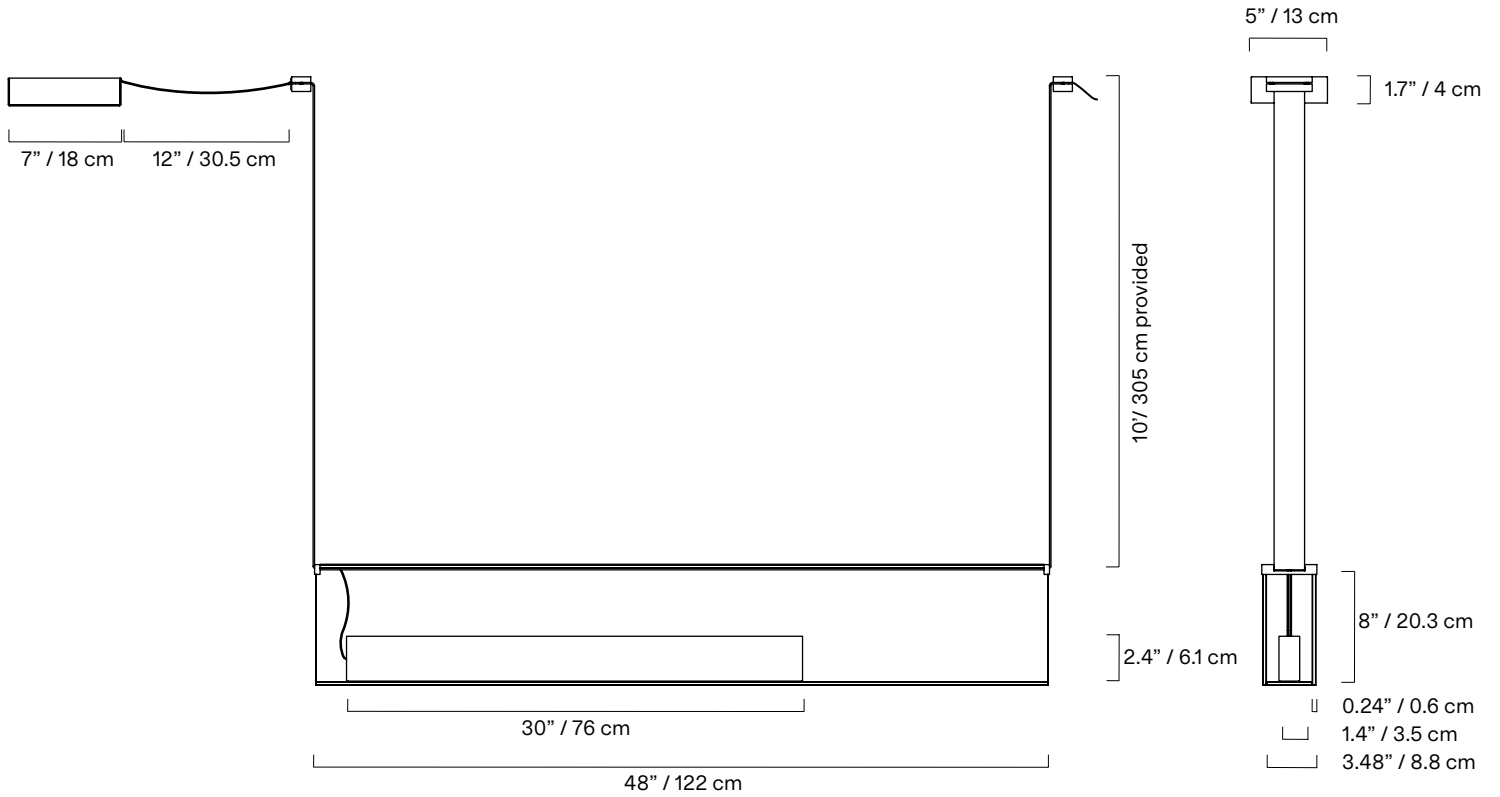

*dimensions are approximate and may vary slightly

GLASS BODY

(*Custom colours available on one or both sides upon request)

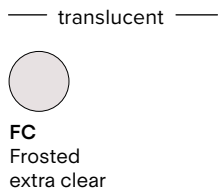
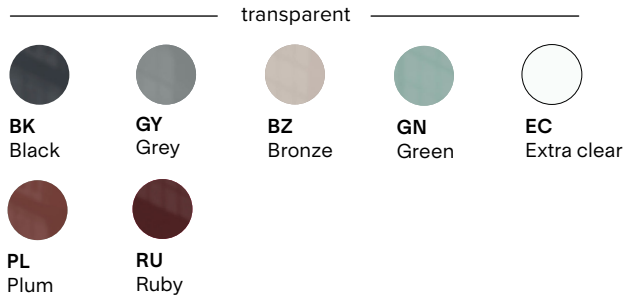

NYLON RIBBON

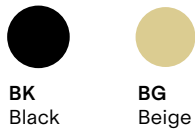

MOUNTING OPTIONS

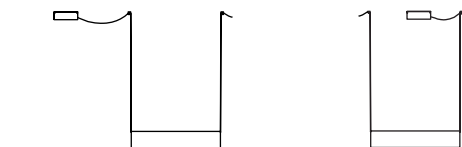
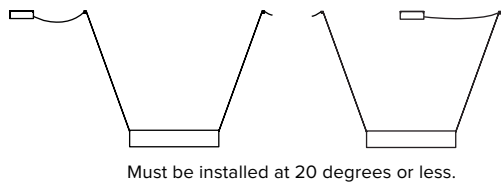

NOTES

- Must be installed by an electrician
- LED may only be changed by Lambert & Fils or other authorized personnel
- Not protected against liquids (refer to IP20)
- Additional charges for modifications or for special orders
- Please refer to maintenance sheet on our website for cleaning instructions

LAMP ANATOMY

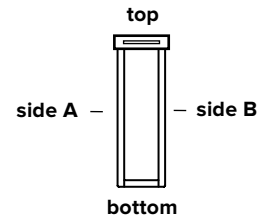
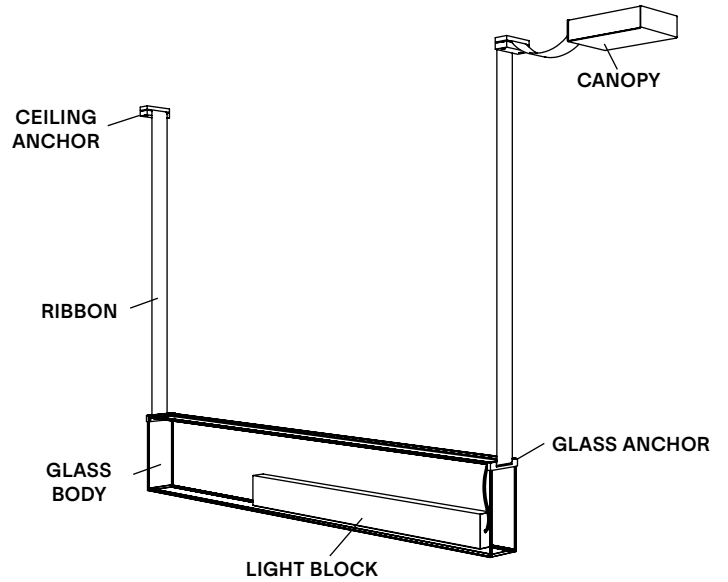

Top and bottom are always ultraclear and not available in colour

		Example	Fill with your selection
COLLECTION	STE Sainte	STE	STE
MODEL	06	06	06
COLOUR SIDE A	BK Black BZ Bronze EC Extra clear FC Frosted extra clear GN Green GY Grey PL Plum RU Ruby CC Custom colour*	BK	
COLOUR SIDE B	BK Black BZ Bronze EC Extra clear FC Frosted extra clear GN Green GY Grey PL Plum RU Ruby CC Custom colour*	BK	
NYLON RIBBON	BK Black BG Beige	BK	
CANOPY	BK Black WH White	BK	
COLOUR TEMPERATURE (CCT)	WL Warm light (2700K) NL Neutral light (3000K) D27 Dim to warm (2700K-2200K) D30 Dim to warm (3000K-2200K) CCT Other CCT available upon request**	WL	
DIMMING	ZT 0-10V (120VAC only) PH Phase dimming DA DALI (220-240VAC only)	ZT	
FULL SKU		STE06BKBKKBKWLZT	
		NOTES	

* Other colours available upon request. Material library on website.





**Specific CCT selection only available in 100k increments, from 2200K to 4000K inclusively and not available with Dim-to-Warm feature.

Sainte 07



Featuring lightweight glass panels, the Sainte's Classic series is destined for residential, hospitality and office interiors. Hung solo or in multiples, Sainte's tones and textures unearth ambiance and imbue a sense of intimacy. A removable aluminum lightbox rests within the translucent glass and can be flipped around, allowing it to cast light up or down.

Created in collaboration with Canadian designer Rachel Bussin.

TYPE	Suspension
CONSTRUCTION	Aluminum polished light block, glass anchor system and ceiling anchors Polyester laminated glass Nylon ribbon PMMA frosted diffuser
SPECIFICATIONS	Source: LED array, integrated Power consumption: 15.4W Colour temperature: 3000K 2700K dim to warm 3000K to 2200K dim to warm 2700K to 2200K Lumen output: 2700K - 699lm Colour rendering index: ≥90 CRI Colour consistency: 3 SDCM Expected lifetime: ≥50 000h
CONTROL	120-277V: On/Off, 0-10V, Phase Dimming (120V only) 220-240V: On/Off, Phase Dimming, DALI Refer to our recommended list of dimmer models
CORD LENGTH	10' / 305 cm each side, width: 2" / 5 cm
WEIGHT	44.1 lb / 20 kg
CERTIFICATIONS	     IP20
WARRANTY	2 years

NOTES

- Luminaire total minimum height (ceiling to lowest point of luminaire) - 30" / 76 cm
- Luminaire Total maximum height (ceiling to lowest point of luminaire) - 144" / 366 cm, contact Lambert & Fils for more options
- Luminaire height is adjustable on site
- For slanted ceiling contact Lambert & Fils

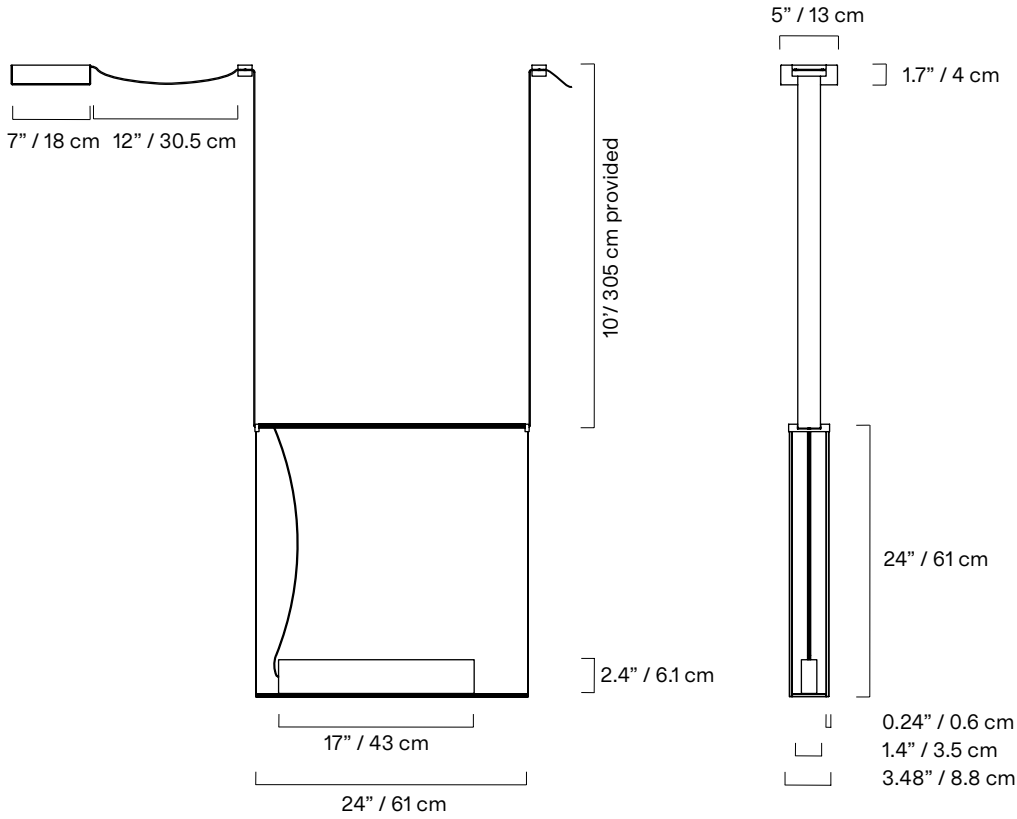

*dimensions are approximate and may vary slightly

GLASS BODY

(*Custom colours available on one or both sides upon request)

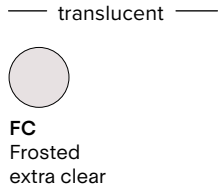
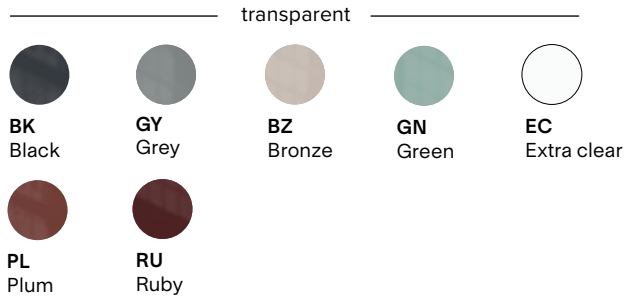

NYLON RIBBON

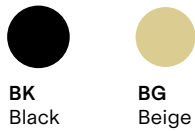

MOUNTING OPTIONS

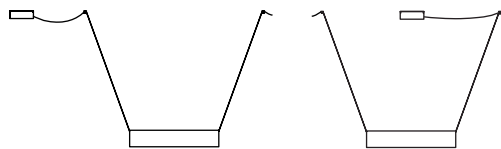

Must be installed at 20 degrees or less.

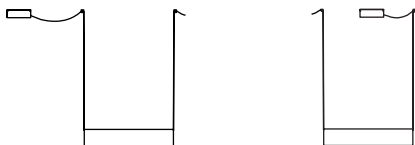

NOTES

- Must be installed by an electrician
- LED may only be changed by Lambert & Fils or other authorized personnel
- Not protected against liquids (refer to IP20)
- Additional charges for modifications or for special orders
- Please refer to maintenance sheet on our website for cleaning instructions

LAMP ANATOMY

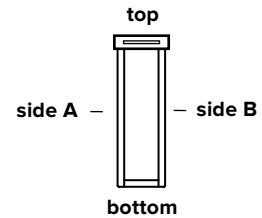
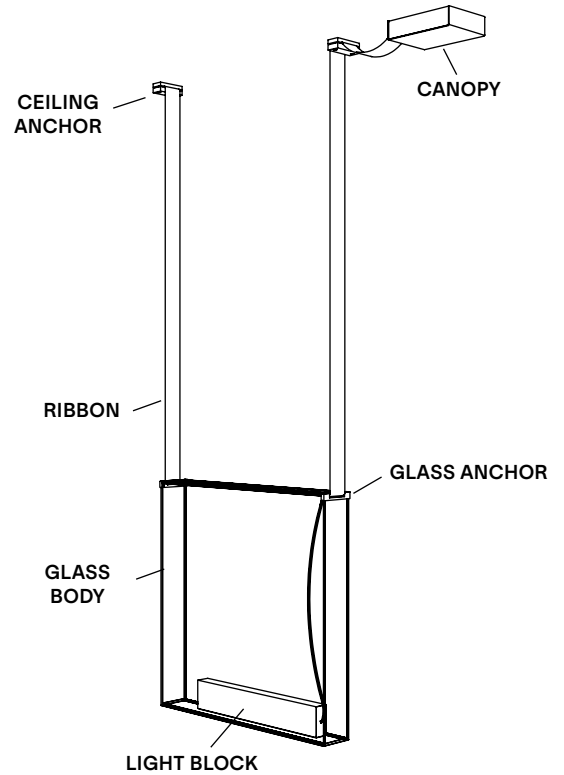

Top and bottom are always ultraclear and not available in colour

		Example	Fill with your selection
COLLECTION	STE Sainte	STE	STE
MODEL	07	07	07
COLOUR SIDE A	BK Black BZ Bronze EC Extra clear FC Frosted extra clear GN Green GY Grey PL Plum RU Ruby CC Custom colour*	BK	
COLOUR SIDE B	BK Black BZ Bronze EC Extra clear FC Frosted extra clear GN Green GY Grey PL Plum RU Ruby CC Custom colour*	BK	
NYLON RIBBON	BK Black BG Beige	BK	
CANOPY	BK Black WH White	BK	
COLOUR TEMPERATURE (CCT)	WL Warm light (2700K) NL Neutral light (3000K) D27 Dim to warm (2700K-2200K) D30 Dim to warm (3000K-2200K) CCT Other CCT available upon request**	WL	
DIMMING	ZT 0-10V (120VAC only) PH Phase dimming DA DALI (220-240VAC only)	ZT	
FULL SKU		STE07BKBKKBKWLZT	
		NOTES	

* Other colours available upon request. Material library on website.





**Specific CCT selection only available in 100k increments, from 2200K to 4000K inclusively and not available with Dim-to-Warm feature.

Sainte 08



Featuring lightweight glass panels, the Sainte's Classic series is destined for residential, hospitality and office interiors. Hung solo or in multiples, Sainte's tones and textures unearth ambiance and imbue a sense of intimacy. A removable aluminum lightbox rests within the translucent glass and can be flipped around, allowing it to cast light up or down.

Created in collaboration with Canadian designer Rachel Bussin.

TYPE	Suspension
CONSTRUCTION	Aluminum polished light block, glass anchor system and ceiling anchors Polyester laminated glass Nylon ribbon PMMA frosted diffuser
SPECIFICATIONS	Source: LED array, integrated Power consumption: 11W Colour temperature: 3000K 2700K dim to warm 3000K to 2200K dim to warm 2700K to 2200K Lumen output: 2700K - 499lm Colour rendering index: ≥90 CRI Colour consistency: 3 SDCM Expected lifetime: ≥50 000h
CONTROL	120-277V: On/Off, 0-10V, Phase Dimming (120V only) 220-240V: On/Off, Phase Dimming, DALI Refer to our recommended list of dimmer models
CORD LENGTH	10' / 305 cm each side, width: 2" / 5 cm
WEIGHT	42.1 lb / 19.1 kg
CERTIFICATIONS	     IP20
WARRANTY	2 years

NOTES

- Luminaire total minimum height (ceiling to lowest point of luminaire) - 34" / 86 cm
- Luminaire Total maximum height (ceiling to lowest point of luminaire) - 148" / 376 cm, contact Lambert & Fils for more options
- Luminaire height is adjustable on site
- For slanted ceiling contact Lambert & Fils

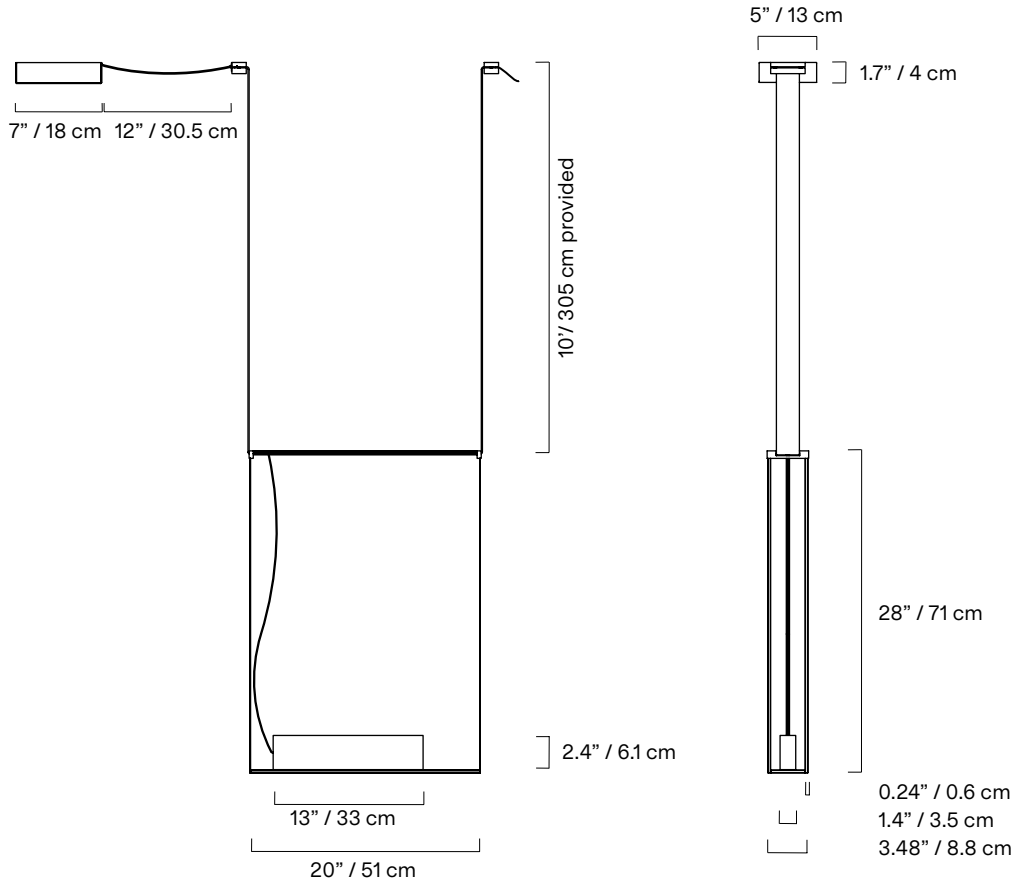

*dimensions are approximate and may vary slightly

GLASS BODY

(*Custom colours available on one or both sides upon request)

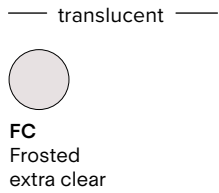
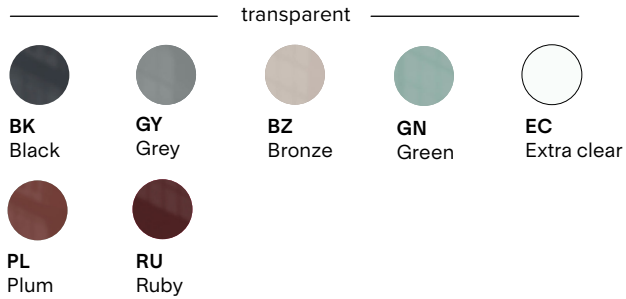

NYLON RIBBON

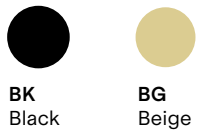

MOUNTING OPTIONS

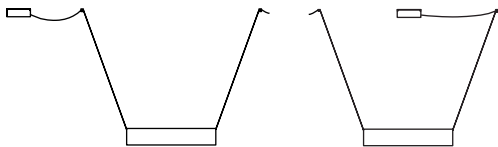

Must be installed at 20 degrees or less.

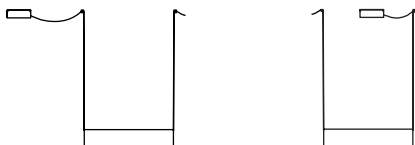

NOTES

- Must be installed by an electrician
- LED may only be changed by Lambert & Fils or other authorized personnel
- Not protected against liquids (refer to IP20)
- Additional charges for modifications or for special orders
- Please refer to maintenance sheet on our website for cleaning instructions

LAMP ANATOMY

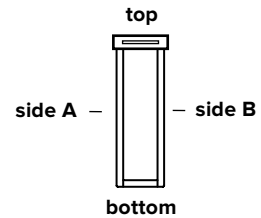
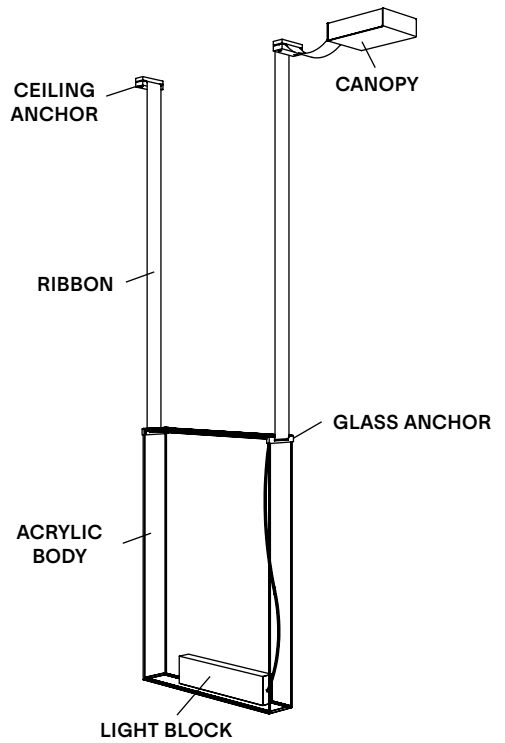

Top and bottom are always ultraclear and not available in colour

		Example	Fill with your selection
COLLECTION	STE Sainte	STE	STE
MODEL	08	08	08
COLOUR SIDE A	BK Black BZ Bronze EC Extra clear FC Frosted extra clear GN Green GY Grey PL Plum RU Ruby CC Custom colour*	BK	
COLOUR SIDE B	BK Black BZ Bronze EC Extra clear FC Frosted extra clear GN Green GY Grey PL Plum RU Ruby CC Custom colour*	BK	
NYLON RIBBON	BK Black BG Beige	BK	
CANOPY	BK Black WH White	BK	
COLOUR TEMPERATURE (CCT)	WL Warm light (2700K) NL Neutral light (3000K) D27 Dim to warm (2700K-2200K) D30 Dim to warm (3000K-2200K) CCT Other CCT available upon request**	WL	
DIMMING	ZT 0-10V (120VAC only) PH Phase dimming DA DALI (220-240VAC only)	ZT	
FULL SKU		STE08BKBKKBKWLZT	
		NOTES	

* Other colours available upon request. Material library on website.





**Specific CCT selection only available in 100k increments, from 2200K to 4000K inclusively and not available with Dim-to-Warm feature.

Sainte 09



Featuring lightweight glass panels, the Sainte's Classic series is destined for residential, hospitality and office interiors. Hung solo or in multiples, Sainte's tones and textures unearth ambiance and imbue a sense of intimacy. A removable aluminum lightbox rests within the translucent glass and can be flipped around, allowing it to cast light up or down.

Created in collaboration with Canadian designer Rachel Bussin.

TYPE	Suspension
CONSTRUCTION	Aluminum polished light block, glass anchor system and ceiling anchors Polyester laminated glass Nylon ribbon PMMA frosted diffuser
SPECIFICATIONS	Source: LED array, integrated Power consumption: 15.4W Colour temperature: 3000K 2700K dim to warm 3000K to 2200K dim to warm 2700K to 2200K Lumen output: 2700K - 699lm Colour rendering index: ≥90 CRI Colour consistency: 3 SDCM Expected lifetime: ≥50 000h
CONTROL	120-277V: On/Off, 0-10V, Phase Dimming (120V only) 220-240V: On/Off, Phase Dimming, DALI Refer to our recommended list of dimmer models
CORD LENGTH	10' / 305 cm each side, width: 2" / 5 cm
WEIGHT	31lb / 14.1 kg
CERTIFICATIONS	     IP20
WARRANTY	2 years

NOTES

- Luminaire total minimum height (ceiling to lowest point of luminaire) - 18" / 46 cm
- Luminaire Total maximum height (ceiling to lowest point of luminaire) - 132" / 335 cm, contact Lambert & Fils for more options
- Luminaire height is adjustable on site
- For slanted ceiling contact Lambert & Fils

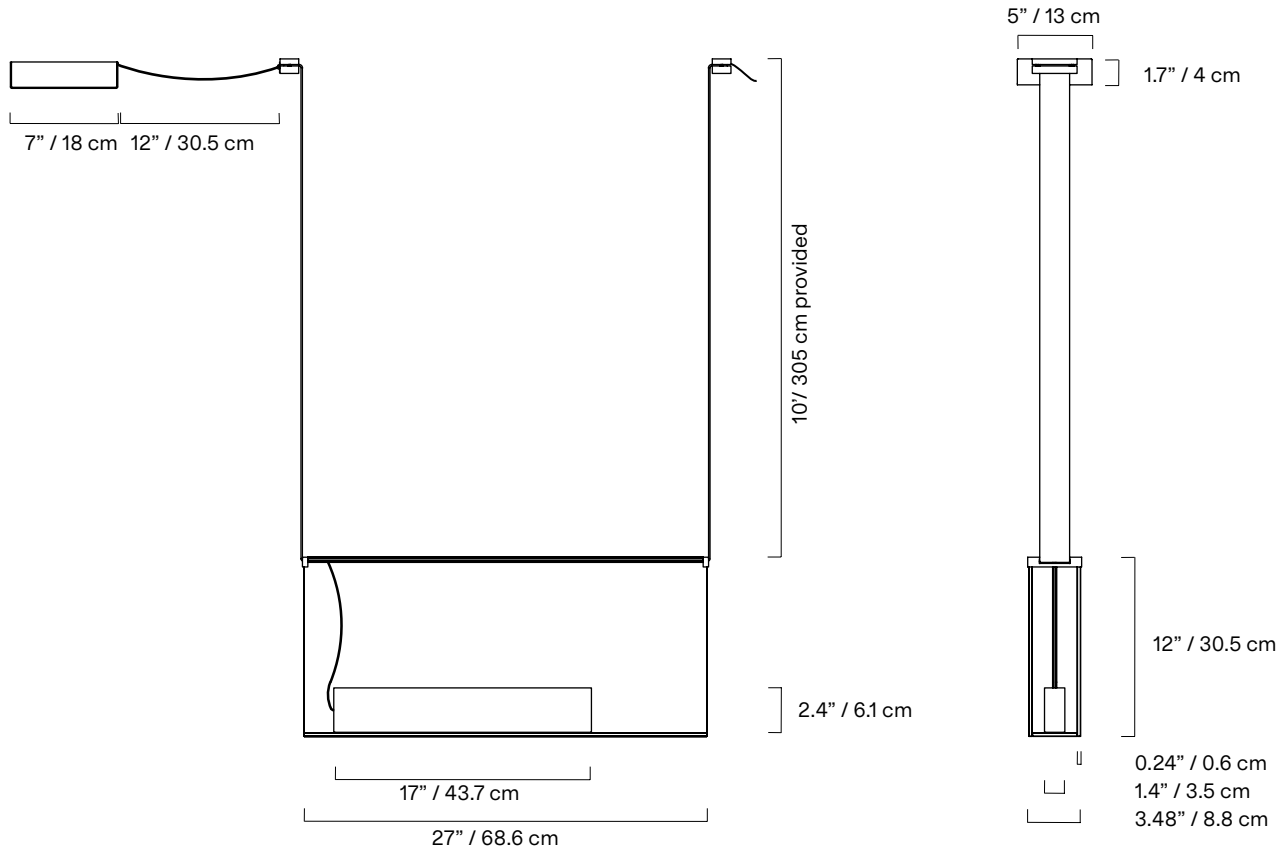

*dimensions are approximate and may vary slightly

GLASS BODY

(*Custom colours available on one or both sides upon request)

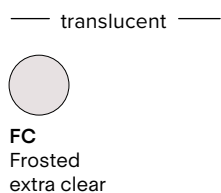
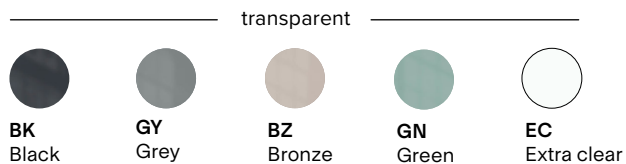

NYLON RIBBON

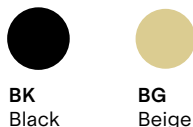

MOUNTING OPTIONS

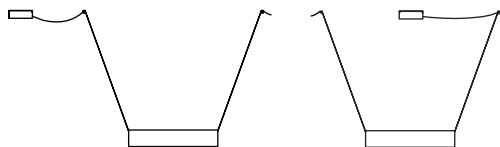

Must be installed at 20 degrees or less.

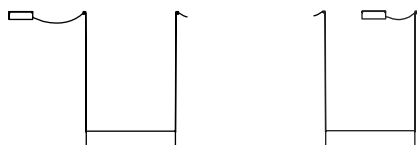

NOTES

- Must be installed by an electrician
- LED may only be changed by Lambert & Fils or other authorized personnel
- Not protected against liquids (refer to IP20)
- Additional charges for modifications or for special orders
- Please refer to maintenance sheet on our website for cleaning instructions

LAMP ANATOMY

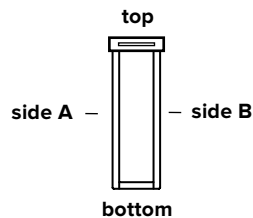
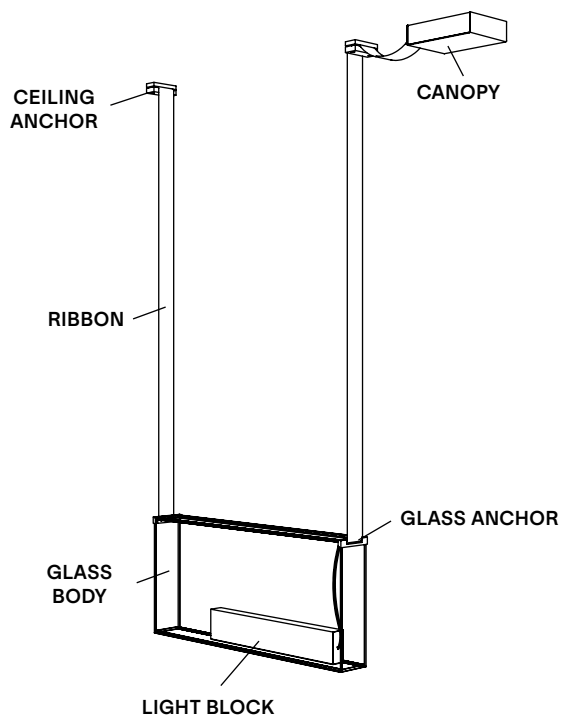

Top and bottom are always ultraclear and not available in colour

		Example	Fill with your selection
COLLECTION	STE Sainte	STE	STE
MODEL	09	09	09
COLOUR SIDE A	BK Black BZ Bronze EC Extra clear FC Frosted extra clear GN Green GY Grey PL Plum RU Ruby CC Custom colour*	BK	
COLOUR SIDE B	BK Black BZ Bronze EC Extra clear FC Frosted extra clear GN Green GY Grey PL Plum RU Ruby CC Custom colour*	BK	
NYLON RIBBON	BK Black BG Beige	BK	
CANOPY	BK Black WH White	BK	
COLOUR TEMPERATURE (CCT)	WL Warm light (2700K) NL Neutral light (3000K) D27 Dim to warm (2700K-2200K) D30 Dim to warm (3000K-2200K) CCT Other CCT available upon request**	WL	
DIMMING	ZT 0-10V (120VAC only) PH Phase dimming DA DALI (220-240VAC only)	ZT	
FULL SKU		STE09BKBKKBKWLZT	
		NOTES	

* Other colours available upon request. Material library on website.





**Specific CCT selection only available in 100k increments, from 2200K to 4000K inclusively and not available with Dim-to-Warm feature.

Sainte 21



Featuring lightweight acrylic panels, the Sainte's Classic series is destined for residential, hospitality and office interiors. Hung solo or in multiples, Sainte's tones and textures unearth ambiance and imbue a sense of intimacy. A removable aluminum lightbox rests within the translucent acrylic and can be flipped around, allowing it to cast light up or down.

Created in collaboration with Canadian designer Rachel Bussin.

TYPE	Suspension
CONSTRUCTION	Aluminum polished light block, anchor system and ceiling anchors Polyester laminated acrylic Nylon ribbon PMMA frosted diffuser
SPECIFICATIONS	Source: LED array, integrated Power consumption: 19.3W Colour temperature 2700K, 3000K, dim to warm. See order guide Lumen output: 2700K - 927lm Colour rendering index: ≥90 CRI Colour consistency: 3 SDCM Expected lifetime: ≥50 000h
CONTROL	120-277V: On/Off, 0-10V, Phase Dimming (120V only) 220-240V: On/Off, Phase Dimming, DALI Refer to our recommended list of dimmer models
CORD LENGTH	10' / 305 cm each side, width: 1.5" / 3.8 cm
WEIGHT	9.1 lb / 4.1 kg
CERTIFICATIONS	    IP20
WARRANTY	2 years

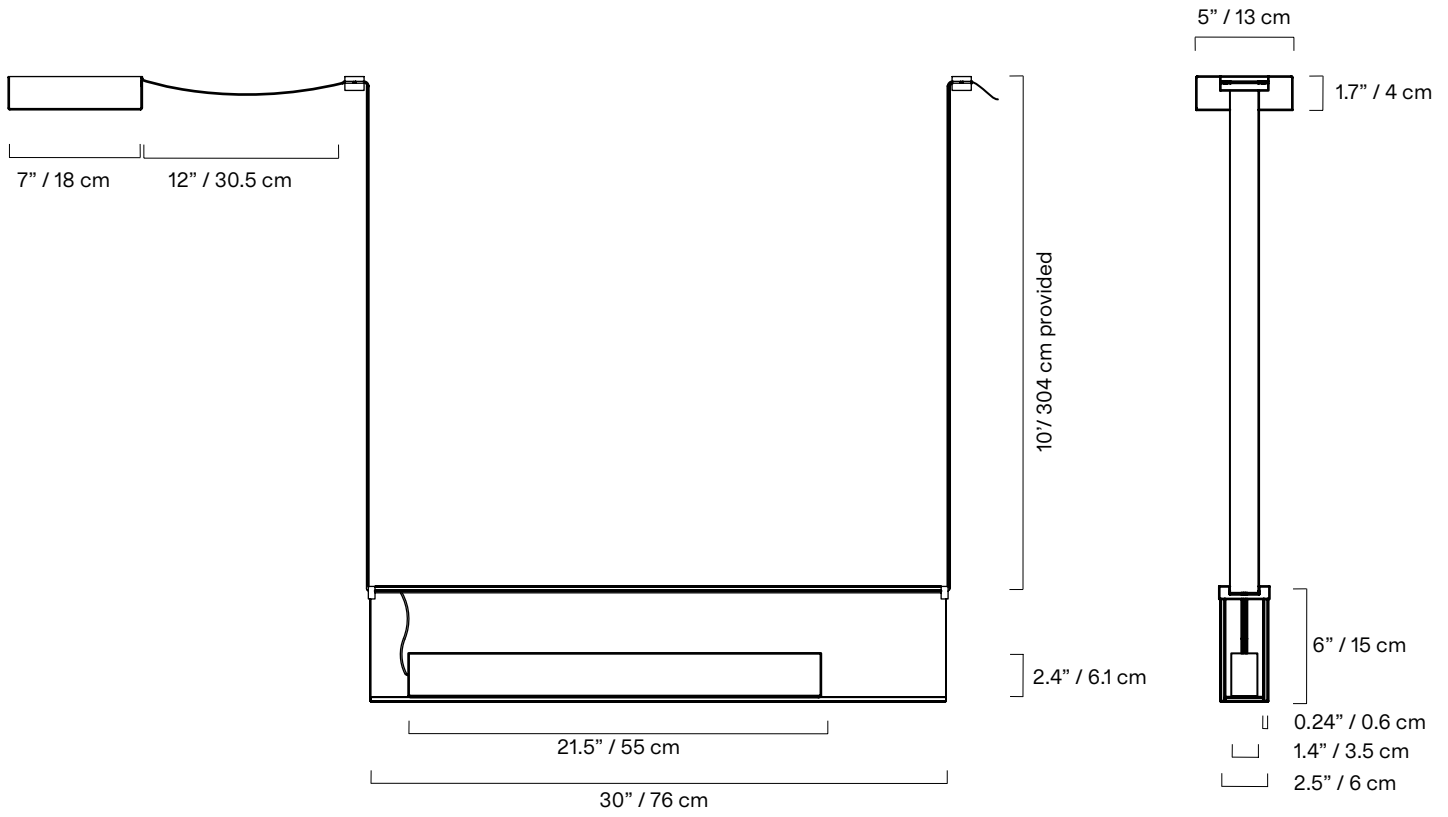

*dimensions are approximate and may vary slightly

ACRYLIC BODY

(*Custom colours available on one or both sides upon request)



BK
Black



BZ
Bronze



EC
Extra clear



GN
Green



GY
Grey

transparent



FC
Frosted
extra clear

translucent

NYLON RIBBON



BK
Black



BG
Beige

MOUNTING OPTIONS

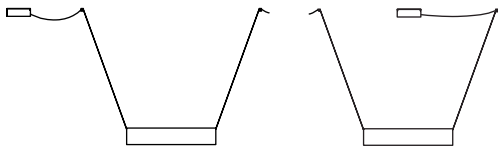

Must be installed at 20 degrees or less.

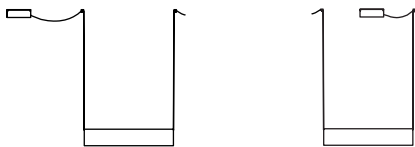

NOTES

- Must be installed by an electrician
- LED may only be changed by Lambert & Fils or other authorized personnel
- Not protected against liquids (refer to IP20)
- Additional charges for modifications or for special orders
- Please refer to maintenance sheet on our website for cleaning instructions

LAMP ANATOMY

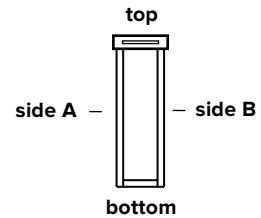
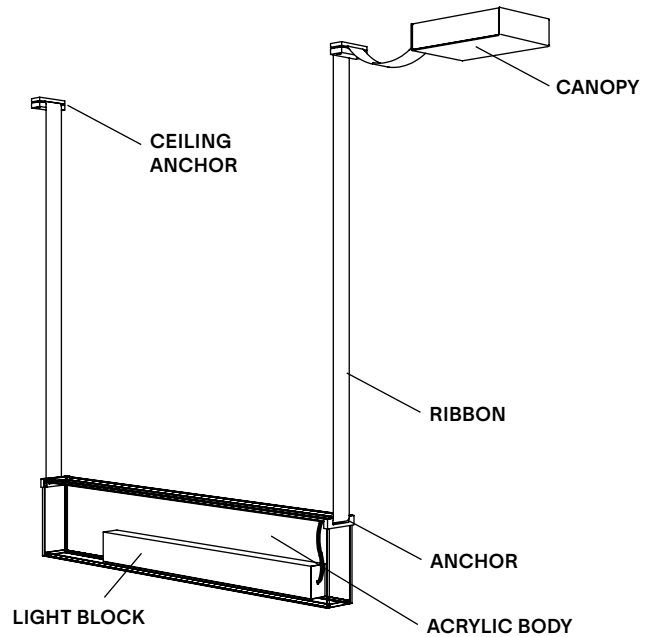

Top and bottom are always ultraclear and not available in colour

		Example	Fill with your selection
COLLECTION	STE Sainte	STE	STE
MODEL	21	21	21
COLOUR SIDE A	BK Black BZ Bronze EC Extra clear FC Frosted extra clear GN Green GY Grey CC Custom colour*	BK	
COLOUR SIDE B	BK Black BZ Bronze EC Extra clear FC Frosted extra clear GN Green GY Grey CC Custom colour*	BK	
NYLON RIBBON	BK Black BG Beige	BK	
CANOPY	BK Black WH White	BK	
COLOUR TEMPERATURE (CCT)	WL Warm light (2700K) NL Neutral light (3000K) D27 Dim to warm (2700K-2200K) D30 Dim to warm (3000K-2200K) CCT Other CCT available upon request**	WL	
DIMMING	ZT 0-10V (120VAC only) PH Phase dimming DA DALI (220-240VAC only)	ZT	
FULL SKU		STE21BKBKKBKWLZT	
		NOTES	





* Other colours available upon request. Material library on website.
 **Specific CCT selection only available in 100k increments, from 2200K to 4000K inclusively and not available with Dim-to-Warm feature.

Sainte 22



Featuring lightweight acrylic panels, the Sainte's Classic series is destined for residential, hospitality and office interiors. Hung solo or in multiples, Sainte's tones and textures unearth ambiance and imbue a sense of intimacy. A removable aluminum lightbox rests within the translucent acrylic and can be flipped around, allowing it to cast light up or down.

Created in collaboration with Canadian designer Rachel Bussin.

TYPE	Suspension
CONSTRUCTION	Aluminum polished light block, anchor system and ceiling anchors Polyester laminated acrylic Nylon ribbon PMMA frosted diffuser
SPECIFICATIONS	Source: LED array, integrated Power consumption: 11W Colour temperature 2700K, 3000K, dim to warm. See order guide Lumen output: 2700K - 499lm Colour rendering index: ≥90 CRI Colour consistency: 3 SDCM Expected lifetime: ≥50 000h
CONTROL	120-277V: On/Off, 0-10V, Phase Dimming (120V only) 220-240V: On/Off, Phase Dimming, DALI Refer to our recommended list of dimmer models
CORD LENGTH	10' / 305 cm each side, width: 1.5" / 3.8 cm
WEIGHT	13.8 lb / 6.3 kg
CERTIFICATIONS	    IP20
WARRANTY	2 years

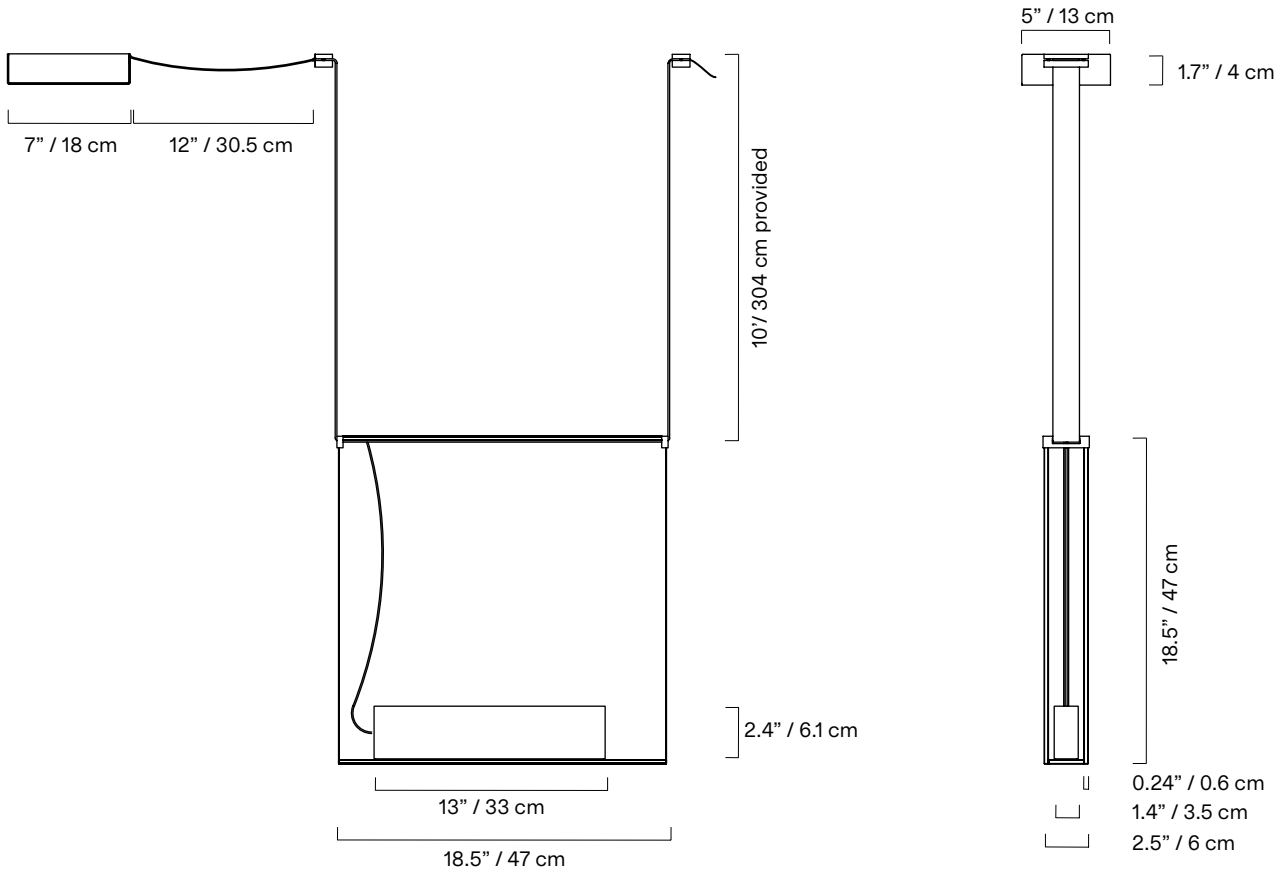

*dimensions are approximate and may vary slightly

ACRYLIC BODY

(*Custom colours available on one or both sides upon request)



BK
Black



BZ
Bronze



EC
Extra clear



GN
Green



GY
Grey

transparent



FC
Frosted
extra clear

translucent

NYLON RIBBON



BK
Black



BG
Beige

MOUNTING OPTIONS

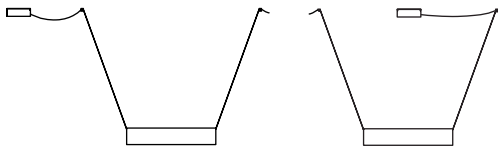

Must be installed at 20 degrees or less.

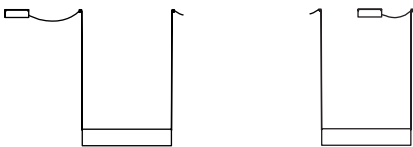

NOTES

- Must be installed by an electrician
- LED may only be changed by Lambert & Fils or other authorized personnel
- Not protected against liquids (refer to IP20)
- Additional charges for modifications or for special orders
- Please refer to maintenance sheet on our website for cleaning instructions

LAMP ANATOMY

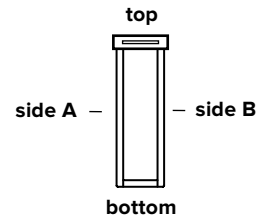
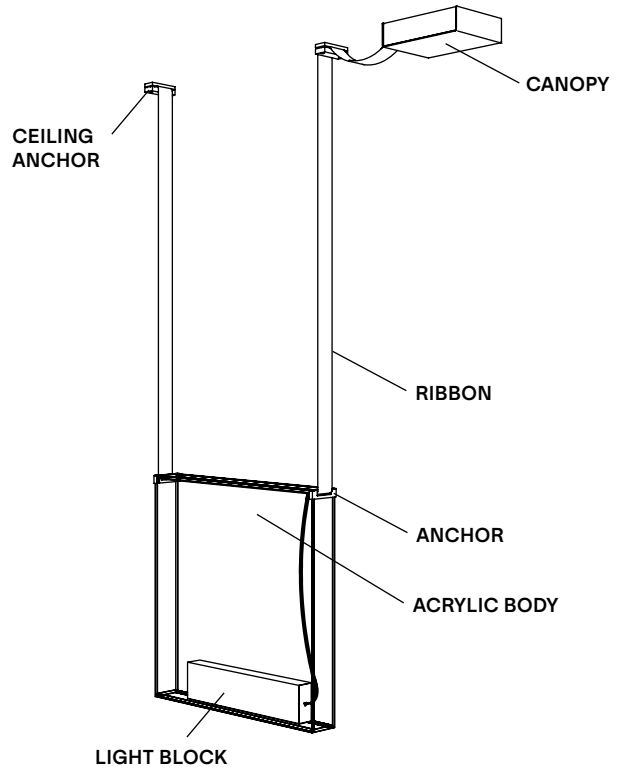

Top and bottom are always ultraclear and not available in colour

		Example	Fill with your selection
COLLECTION	STE Sainte	STE	STE
MODEL	22	22	22
COLOUR SIDE A	BK Black BZ Bronze EC Extra clear FC Frosted extra clear GN Green GY Grey CC Custom colour*	BK	
COLOUR SIDE B	BK Black BZ Bronze EC Extra clear FC Frosted extra clear GN Green GY Grey CC Custom colour*	BK	
NYLON RIBBON	BK Black BG Beige	BK	
CANOPY	BK Black WH White	BK	
COLOUR TEMPERATURE (CCT)	WL Warm light (2700K) NL Neutral light (3000K) D27 Dim to warm (2700K-2200K) D30 Dim to warm (3000K-2200K) CCT Other CCT available upon request**	WL	
DIMMING	ZT 0-10V (120VAC only) PH Phase dimming DA DALI (220-240VAC only)	ZT	
FULL SKU		STE22BKBKKBKWLZT	
		NOTES	

* Other colours available upon request. Material library on website.
 **Specific CCT selection only available in 100k increments, from 2200K to 4000K inclusively and not available with Dim-to-Warm feature.

TESTED DIMMER COMPATIBILITY LIST - 120V*

Phase cut dimming (leading edge or trailing edge**)

DIMMER BRAND	MODEL	MAX LEVEL	MIN LEVEL	DIMMING PROTOCOL
Cooper	DLC03P	100%	2%	Phase Cut
Leviton	IPE04-1LZ	100%	6%	Phase Cut
Leviton	IPI06-1LZ	100%	1%	Phase Cut
Leviton	VPE06-1LZ	100%	10%	Phase Cut
Lutron	DVCL-153P	100%	1%	Phase Cut
Lutron	DVELV-303P	100%	7%	Phase Cut
Lutron	FAELV-500	100%	12%	Phase Cut
Lutron	MAELV-600	100%	12%	Phase Cut
Lutron	SELV-300P	100%	8%	Phase Cut
Lutron	TGCL-153P	100%	6%	Phase Cut

EU ENERGY LABEL

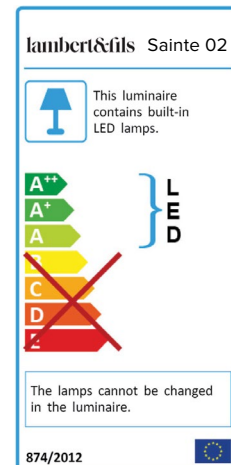

TESTED DIMMER COMPATIBILITY LIST - 230V*

Phase cut dimming (leading edge or trailing edge**)

DIMMER BRAND	MODEL	MAX LEVEL	MIN LEVEL	DIMMING PROTOCOL
Busch-Jaeger	2250U	100%	11.0%	Phase Cut
Busch-Jaeger	6523U	100%	0.6%	Phase Cut
CLIPSAL	32E450TM	100%	3.7%	Phase Cut
CLIPSAL	32E450UDM	100%	4.8%	Phase Cut
EHMANN	T46S	100%	9.0%	Phase Cut
E-Lite	U116	100%	5.0%	Phase Cut
ELKO	315GLE	100%	0.5%	Phase Cut
ELKO	315GLE-2Pole	100%	3.0%	Phase Cut
Feller	40200.LED.F.61	100%	7.0%	Phase Cut
Finder	15.91.8	100%	5.2%	Phase Cut
Gira	117600/I01	100%	7.8%	Phase Cut
Gira	118200/I01	100%	6.0%	Phase Cut
Hager	EVN011	100%	2.8%	Phase Cut
Hager	EVN012	100%	2.9%	Phase Cut
JUNG	225TDE	100%	4.0%	Phase Cut
JUNG	254UDIE1	100%	10.0%	Phase Cut
Legrand	HPM CAT400T	100%	4.0%	Phase Cut
SAL	SDA450	100%	5.0%	Phase Cut
SAL	SDD350	100%	0.0%	Phase Cut
Schneide	40300.RC	100%	6.0%	Phase Cut

*Other dimmers can yield good results and we recommend conducting your own test before final installation.

Some dimmers require a minimum load, check specifications.

*Other dimmers that specify LED lamp compatibility may operate without issue.

We recommend conducting your own test before final installation.

**Leading edge is also known as TRIAC or Forward Phase.

Trailing edge is also known as ELV or Reverse Phase.